

MultiBac™

Multi-Protein Expression in Insect Cells



User Manual

Version 6.0 (July 2017)

TABLE OF CONTENTS

A. MultiBac™ Kit Contents	- 2 -
A. MultiBac™ Kit Plus Competent Cells Contents	- 2 -
Reagents to be supplied by user	- 3 -
B. Overview	- 5 -
C. New Baculovirus Tools for Multigene Applications	- 10 -
C.1. Transfer vectors: the Acceptor-Donor recombineering system.	- 10 -
C.2. Generating multigene expression cassettes	- 13 -
C.2.1. Multigene construction via homing endonuclease/BstXI multiplication	- 13 -
C.2.2. Multigene construction using Cre-Lox recombination	- 16 -
C.2.3. Combining HE/BstXI cycling and Cre-Lox recombination	- 17 -
C.3. Baculovirus engineered for improved protein production.	- 18 -
C.4. Introducing additional control elements	- 19 -
D. Protocols	- 20 -
D.0 Introductory remarks	- 20 -
D.1 Cloning into pACEBac or pIDx transfer vectors	- 20 -
D.2 Multiplication by using the HE and BstXI sites	- 20 -
D2.1 Protocol 1. Multiplication by using homing endonuclease/BstXI.	- 21 -
D.3 Cre-LoxP reaction of Acceptors and Donors	- 24 -
D 3.1. Protocol 2: Cre-LoxP fusion of Acceptors and Donors	- 24 -
D 3.2. Protocol 3. Deconstruction of fusion vectors by Cre	- 27 -
D.4. Transposition protocol for pACEBac derivatives (electroporation).	- 30 -
D.5. Bacmid preparation and infection of insect cells.	- 30 -
E. Appendix	- 32 -
E.1. Verifying bacmid integrity in DH10MultiBac™ cells	- 32 -
E.2. Preparing competent DH10MultiBac™/DH10EmBacY cells	- 32 -
E.2.1 Protocol for electrocompetent cells	- 32 -

E.2.2 Protocol for chemically competent cells	- 33 -
E.3. Preparing bacterial stocks from agar stabs	- 34 -
E.3. MultiBac™ vectors: maps, sequences, restriction	- 36 -
E.3.1 Acceptor vectors	- 37 -
E.3.1.1 pACEBac1: 2904 bp	- 37 -
E.3.1.1 pACEBac2: 2761 bp	- 39 -
E.3.2 Donor vectors	- 41 -
E.3.2.1 pIDC: 2312 bp	- 41 -
E.3.2.2 pIDK: 2281 bp	- 43 -
E.3.2.3 pIDS: 2231 bp	- 45 -
E.3.3. Analytical restriction digest patterns	- 47 -
E.3.4 MultiBac™ and EmBacY baculoviral genomes	- 48 -
F. References	- 49 -
G. Purchaser Notification	- 51 -

MultiBac™ Kit Contents:

- **Plasmid acceptor vectors**

pACEBac1, pACEBac2; approx. 5 µg DNA per vial (in buffer solution)

keep at 4°C for short-term storage and in a freezer at -20°C or lower for medium- and long-term storage (take care to avoid repeated freeze-thaw cycles, e.g. by aliquotting DNA prior to freezing)

- **Plasmid donor vectors**

pIDC, pIDK, pIDS; approx. 5 µg DNA per vial (in buffer solution)

keep at 4°C for short-term storage and in a freezer at -20°C or lower for medium- and long-term storage (take care to avoid repeated freeze-thaw cycles, e.g. by aliquotting DNA prior to freezing)

- **E. coli strains as agar stabs**

a) *E. coli* strains harboring DH10MultiBac™ and DH10EMBacY bacmid (1 vial each)

The EmBacY backbone contains a constitutively expressing YFP expression cassette which allows for easy monitoring of viral titres via fluorescence without plaque assays.

c) pirHC, pirLC cells[†] (1 vial each)

For propagation and amplification of donor vectors, donor multigene expression constructs or donor-donor fusions

Keep agar stabs at 4°C or at RT; **do not freeze!** We recommend to immediately prepare glycerol stocks from streaked bacterial colonies (see p. 34).

[†] *E. coli* strains expressing the *pir* gene for propagation of donor vectors (any other strain with *pir*⁺ background can be used as well). LC: low copy number propagation, HC: high copy number propagation of plasmids with R6Kγ origin.

MultiBac™ Kit Plus Competent Cells Contents.

North America Only, from Intact Genomics (St. Louis, USA)

- **Plasmid acceptor vectors**

pACEBac1, pACEBac2; approx. 5 µg DNA per vial (in buffer solution)

keep at 4°C for short-term storage and in a freezer at -20°C or lower for medium- and long-term storage (take care to avoid repeated freeze-thaw cycles, e.g. by aliquotting DNA prior to freezing)

- **Plasmid donor vectors**

pIDC, pIDK, pIDS; approx. 5 µg DNA per vial (in buffer solution)

keep at 4°C for short-term storage and in a freezer at -20°C or lower for medium- and long-term storage (take care to avoid repeated freeze-thaw cycles, e.g. by aliquotting DNA prior to freezing)

- **E. coli strains as chemical competent cells**

a) *E. coli* strain harboring DH10EMBacY bacmid (5 aliquots of 100µl each of chemical competent cells)

The EMBacY backbone contains a constitutively expressing YFP expression cassette which allows for easy monitoring of viral titres via fluorescence without plaque assays. Please see section 4.4 for a schematic description of the genome.

b) *E. coli* strain harboring DH10MultiBac bacmid (5 aliquots of 50µl each of chemical competent cells)

The MultiBac backbone is identical to EMBacY except missing the YFP cassette. Please see section 4.4 for a schematic description of the genome.

c) pirHC cells[†] (5 aliquots 100µl each chemical competent cells)

For propagation and amplification of donor vectors, donor multigene expression constructs or donor-donor fusions

Keep competent cells at -80°C **do not store at -20!**

[†] *E. coli* strains expressing the *pir* gene for propagation of donor vectors (any other strain with *pir*⁺ background can be used as well). HC: high copy number propagation of plasmids with R6Kγ origin.

Reagents to be supplied by user (see also section D. Protocols)

- Restriction enzymes
- Homing endonucleases PI-SceI and I-CeuI
- Insect cells, e.g. Sf9, Sf21 or High-Five™
- T4 DNA ligase
- Cre recombinase
- Standard *E. coli* strains for cloning (such as TOP10, DH5 α , HB101 etc.)
- Standard laboratory buffers, solutions, media and equipment for bacterial and insect cell culture, transformation etc.
- Commercially available transfection reagents, e.g. FuGENE® (Roche), jetPEI™ (Polyplus transfection), GeneJuice, etc.; alternatively, equipment for electroporation
- Antibiotics, chemicals (e.g IPTG, X-Gal, etc.)

B. Overview

This manual introduces a set of novel baculovirus transfer vectors that specifically enable multigene applications (Trowitzsch et al., 2010; Vijayachandran et al, 2011). These transfer vectors are accompanied by modified recipient baculovirus DNA that has been engineered towards improved protein production. This manual also presents a simple and rapid transposition method for integrating your gene(s) of interest into the baculoviral genome.

The role of protein interaction networks (the so-called **interactome**; reviewed e.g. in Figeys, 2008; Charbonnier et al., 2008) has become an intense focus of biological research efforts in the post-genomic era as most proteins have been shown to work together structurally and/or functionally in complexes for most basic cellular functions (transcription, translation, DNA replication and repair, cell cycle, protein quality control, etc.) but also dynamically in response to internal or environmental stimuli (inflammasome, signaling cascades, etc.).

Some of the identified multi-protein complexes are expressed at only low abundance in their native cells or such complexes exist only for brief periods (i.e. they are transitory in nature). This makes analysis of their structure-function difficult but this can be remedied by using recombinant technologies to facilitate large-scale heterologous protein production. Currently, recombinant expression methods require a disproportionate investment in both labor and materials prior to multi-protein expression, and, once expression has been established, provide little or no flexibility for rapidly altering the multiprotein components, which is a prerequisite for revising expression studies.

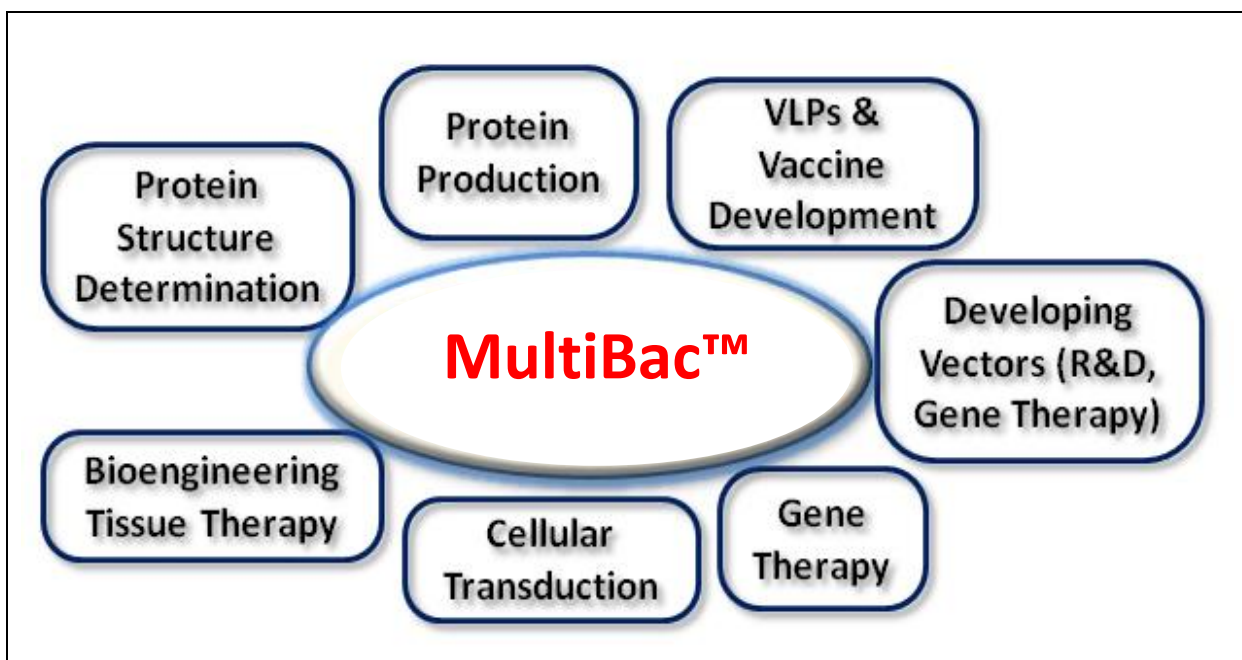

Figure 1. Applications of baculoviral expression systems (BEVS). Some of these are closely intertwined, e.g. transducing cells opens up the path for gene therapy and tissue therapy in mammalian cells.

The baculoviral expression system (BEVS) in its various shapes and forms has become a popular eukaryotic expression system, especially for multiple proteins. Yet, it has been adapted for other applications as well (see Figure 1), e.g. the generation of virus-like particles, bioengineering and tissues therapy research, transduction of mammalian cells, etc. The baculovirus expression system introduced here (see also Trowitzsch et al., 2010) boasts three major advances that are instrumental in fully exploiting the potential of this heterologous protein production system:

1. New transfer vectors (pACEBac1, pACEBac2, pIDC, pIDK, pIDS; see Figure 2) that contain a homing endonuclease-based multiplication module. These vectors greatly facilitate modular combination of heterologous genes (in their respective gene expression cassettes) with a minimum requirement for unique restriction sites (BstXI). Baculoviral promoters (currently p10 and polh very late promoters) can be exchanged in our vectors for other promoter sequences (early and late viral, mammalian) if desired. Likewise, terminator sequences (currently SV40, HSVtk) can be substituted as required.

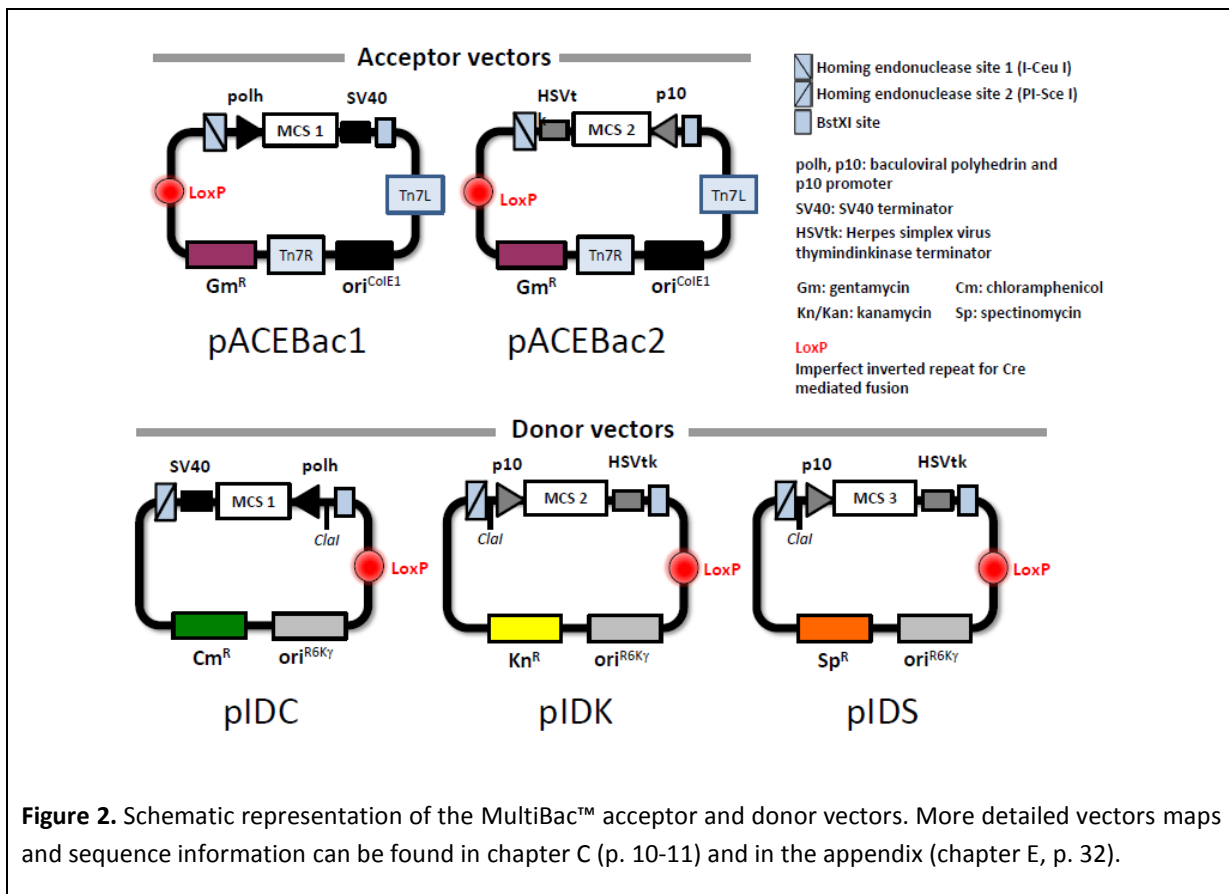
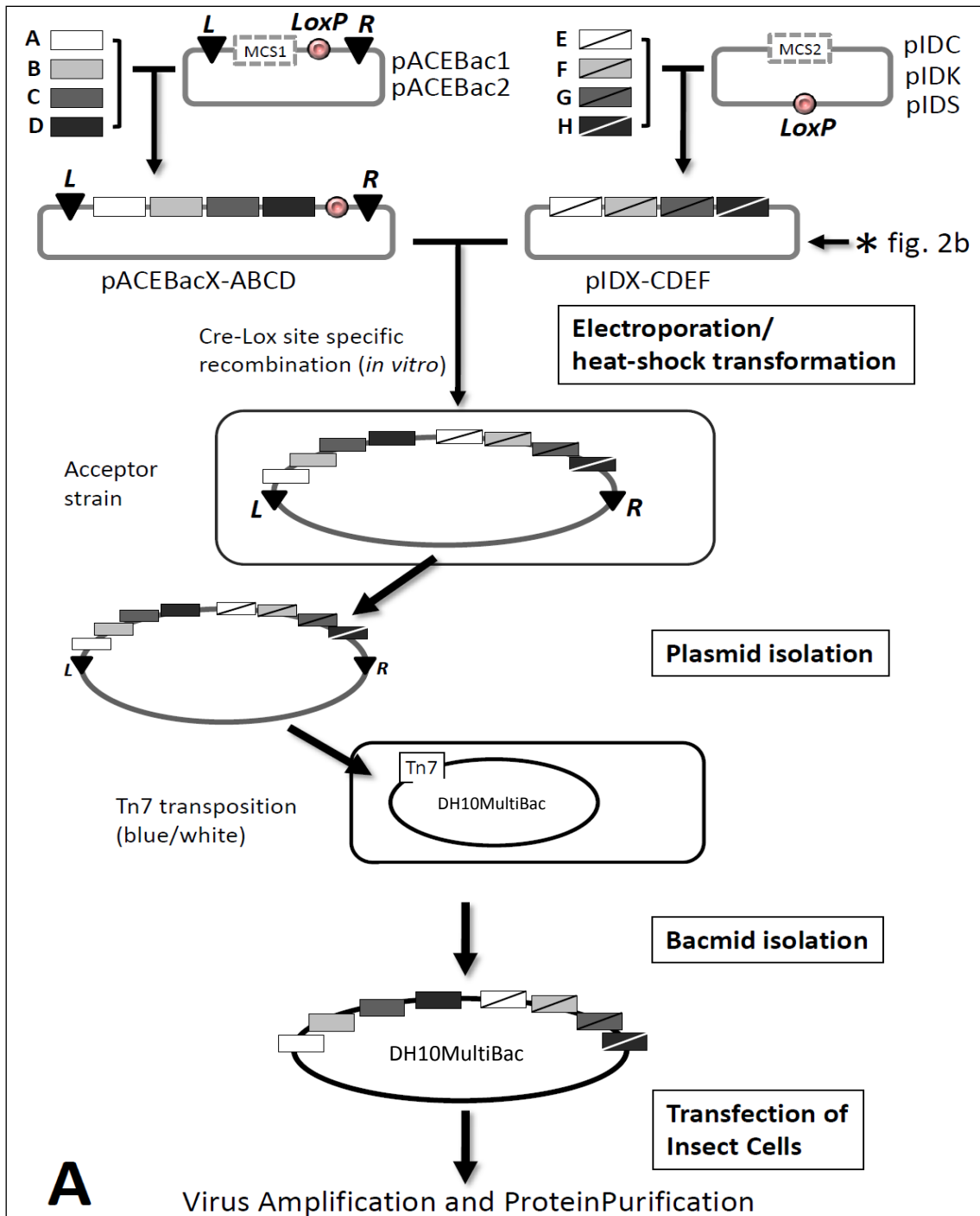

Figure 2. Schematic representation of the MultiBac™ acceptor and donor vectors. More detailed vectors maps and sequence information can be found in chapter C (p. 10-11) and in the appendix (chapter E, p. 32).

2. The baculovirus genome has been engineered to improve its protein production properties. Disruption of two baculoviral genes improves the integrity of cellular compartments during infection and protein production (see below). The quality of proteins produced by this system is significantly improved by curtailing virus-dependent proteolytic activity and reducing cell lysis.

3. New protocol for rapid generation of multigene expression constructs via Cre-LoxP recombineering. The resulting multigene fusion is then incorporated into baculovirus DNA by accessing the viral genome via a specific site (see Figure 3). This protocol can be used to integrate multigene cassettes with coding sequences for multiprotein complex subunits into MultiBac™, but also to integrate specific enzymes (kinases, acetylases etc.) for modifying the proteins under investigation.



A

Virus Amplification and Protein Purification

Figure 3. Schematic overview of the MultiBac™ system and its application. Genes of interest are assembled into multigene expression cassettes using the multiplication module present on the donor (pIDC, pIDK, pIDS) and acceptor vectors (pACEBac1, pACEBac2). Acceptor-donor fusions can then be generated by Cre-LoxP recombination. These multigene fusions contain one Acceptor and one to several Donor vectors, each with one or several genes of interest (here A-H). Desired Acceptor-Donor combinations are identified by transforming in *E. coli* and subsequent antibiotic selection. Acceptor vectors contain the DNA elements required for integration into the baculovirus via Tn7 transposition. DH10MultiBac™ *E. coli* cells contain the recipient baculovirus and also the transposase required for Tn7 transposition for integrating acceptor and acceptor-

donor derivatives that are transformed into these cells. Colonies containing bacmid carrying integrated multigenecassettes are identified by blue/white screening (Tn7 transposition disrupts expression of the lacZ α peptide) plus gentamycin resistance, and optionally through selective resistance markers introduced via Cre-catalyzed integration and hosted on the acceptor, donor or acceptor-donor derivatives). Bacmid DNA is prepared from selected clones and used to transfect insect cells for protein production. LoxP sites in the acceptor-donor fusions have been omitted for reasons of clarity.

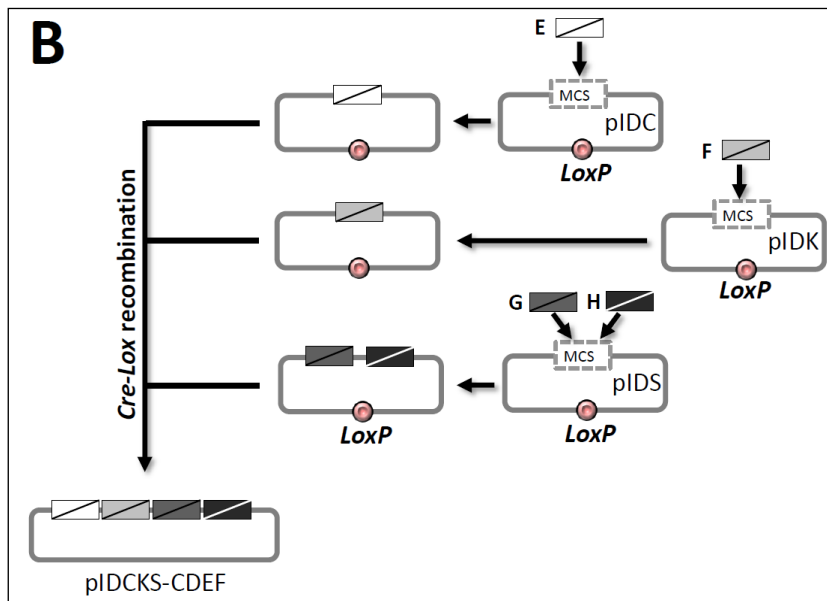
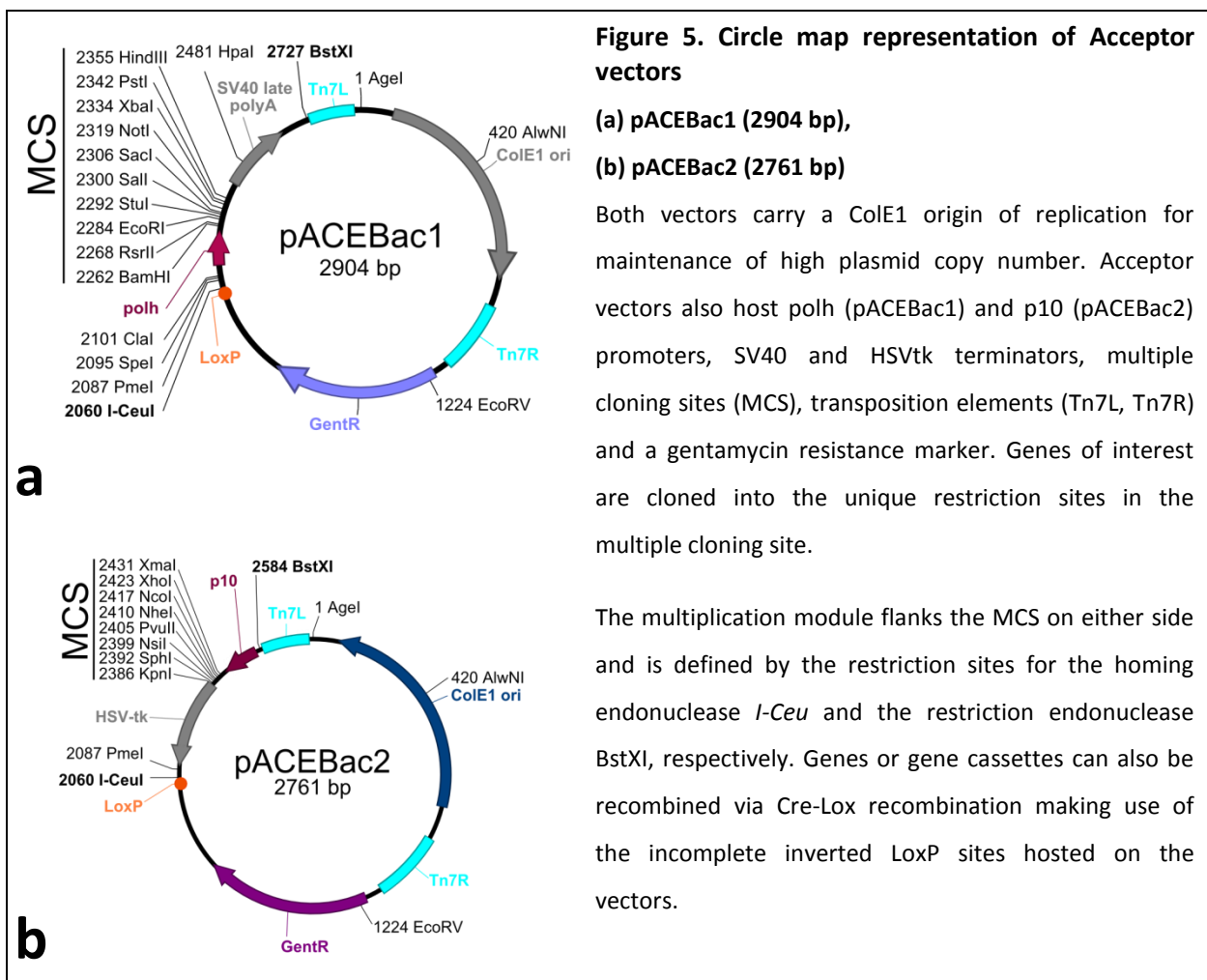

Figure 4. Generation of multigenedonor constructs through Cre-Lox fusion. As indicated in Figure 3, donor multigeneexpression cassette constructs can also be generated by Cre-Lox recombination. Individual or multiple gene cassettes are cloned into the multiple cloning site via standard restriction-ligation cloning or, when introducing multiple gene cassettes, homing endonuclease /BstXI cloning. The gene cassettes harbored on different donor vectors are then merged into a single vector construct via Cre-Lox recombination. This construct will differ from the multigeneconstructs in Figure 3 with respect to selective markers. While the multigeneconstruct in Figure 3 carries only one antibiotic resistance marker, the construct in this scheme will carry three, one from each donor vector. This will allow selection of multigeneconstructs with higher stringency by subjecting the constructs to a multi-antibiotic selection regimen (refer to protocol 2). LoxP sites in the donor fusion have been omitted for reasons of clarity.

C. New Baculovirus Tools for Multigene Applications

C.1. Transfer vectors: the Acceptor-Donor recombinering system.

The **Acceptor vectors** pACEBac1 and pACEBac 2 contain multiple cloning sites (see Appendix) flanked by either a polh or p10 promoters and SV40 or HSVtk polyA signal sequences, respectively. A multiplication module M – defined by the homing endonuclease site I-CeuI and a corresponding BstXI site (see Figure 5) – allows integration of multiple gene cassettes (ORFs and associated regulatory regions). The sequences used for Tn7 transposition (Tn7L and Tn7R) encompass the expression cassettes and a gentamycin resistance marker.



The **Donor vectors** pIDC, pIDS, pIDK are similar to the acceptor vectors with respect to their over-all design. The multiple cloning site is bracketed by a multiplication element (in this case, PI-SceI /BstXI) to enable concatenation of inserts between the different donor vectors. Vectors also contain a LoxP incomplete inverted repeat to create acceptor-donor or donor-donor fusions. The vectors contain “tell-tale” resistance markers (pIDC: chloramphenicol, pIDK: kanamycin, pIDS: spectinomycin) and, importantly, a conditional R6Kγ origin of replication which makes its propagation dependent on the expression of the *pir* gene in the prokaryotic host (such as the pirLC and pirHC cells contained in the kit).

Figure 6. Circle map representation of Donor vectors

a) pIDC, b) pIDK, c) pIDS.

Circle maps show promoters (*polh*, *p10*), terminators (SV40, HSVtk), multiple cloning sites (MCS), the incomplete inverted repeat for *cre-lox* site-specific recombination (LoxP) and a resistance marker (chloramphenicol, kanamycin, and spectinomycin, respectively). Genes of interest are cloned into the MCS using unique restriction sites. The multiplication module consists of the homing endonuclease site PI-SceI and the restriction endonuclease site BstXI.

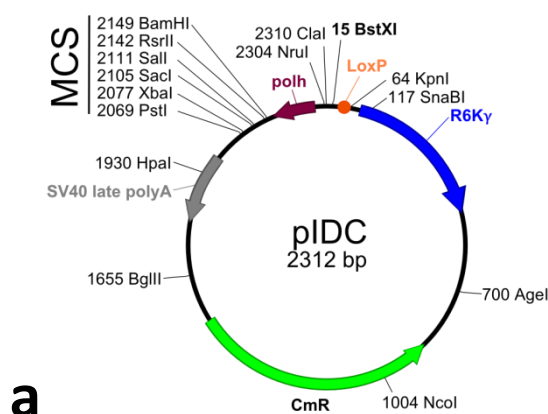

a

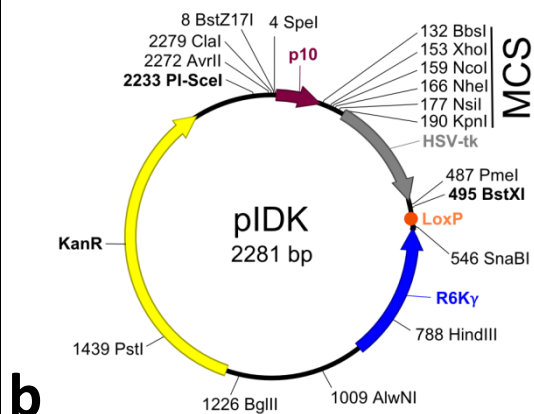

b

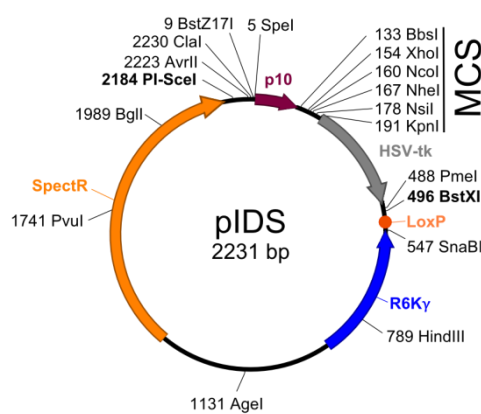

c

Currently, the MultiBac™ vectors do not contain DNA sequences coding for affinity tags that will facilitate purification or solubilization of the protein(s) of interest. Tags that are typically used are C- or N-terminal oligohistidine tags, with or without protease sites for tag removal. They can be introduced by designing the respective PCR primers used for amplification of the genes of interest. We recommend outfitting Donors or Acceptors of choice with any custom tag that is favored in individual

user laboratories prior to inserting recombinant genes of interest. This is best done by using a design that will, after tag insertion, still be compatible with the recombination-based principles of MultiBac™ system usage.

C.2. Generating multigene expression cassettes

C.2.1. Multigene construction via homing endonuclease/*Bst*XI multiplication

The acceptor and donor vectors are suited for generating multigene expression cassettes from individual gene expression cassettes (complete with regulatory regions such as promoter and terminator) via a multiplication module bracketing the multiple cloning site (MCS). All MultiBac™ vectors contain a homing endonuclease (HE) site and a matching designed *Bst*XI site that envelop the MCS. Homing endonucleases have long recognition sites (20-30 base pairs or more). Although not all equally stringent, homing endonuclease sites are most probably unique in the context of even large plasmids, or, in fact, entire genomes.

The logic of multiplication is illustrated below. The homing endonuclease site can be used to insert entire expression cassettes into a vector already containing one gene or several genes of interest as separate expression cassettes. The only prerequisite for assembling multigene expression cassettes is that the homing endonucleases and restriction enzymes used for multiplication (*I-CeuI*/*PI-SceI* and *Bst*XI) are unique, which can be easily accomplished for instance by site directed mutagenesis prior to multigene cassette assembly. First, individual genes are cloned into the multiple cloning sites of the acceptor and donor vectors. The entire expression cassette, including promoter and terminator, is then excised by *I-CeuI* and *Bst*XI (acceptors) or *PI-SceI* and *Bst*XI (donors) digestion. The resulting fragment is placed into the multiplication module of another acceptor or donor vector containing single or multiple gene cassettes. The restriction sites involved are eliminated in the process and multiplication can be repeated iteratively using the module present in the inserted cassette. Moreover, promoter and terminator sequences can be easily modified if desired using appropriate restriction sites in our vectors. Please note that multiplication cannot be accomplished from donors to vectors and vice versa since the overhangs generated by endonuclease digestion are incompatible.

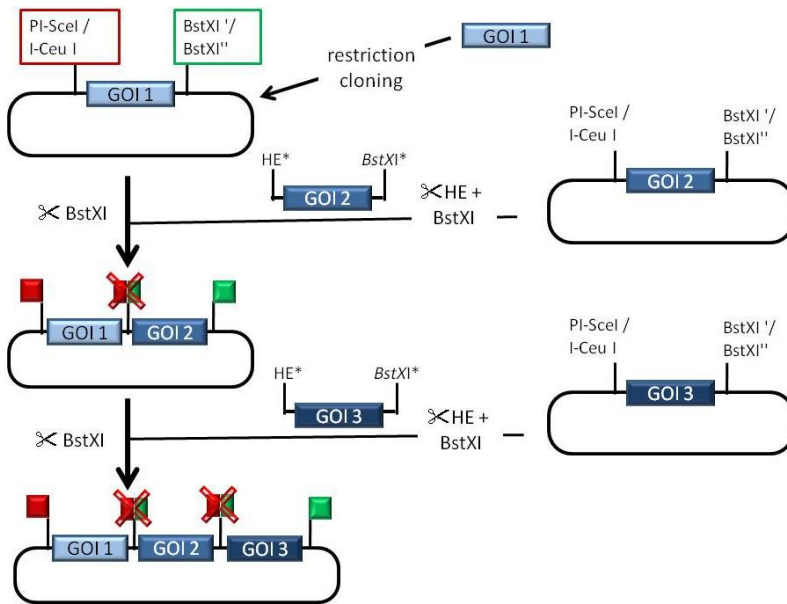

Figure 7. Assembling individual gene cassettes into multigene expression cassettes. The logic of multiplication is shown schematically. The expression cassette containing the gene of choice (denoted as GOI2 in this case) is excised by digestion with the homing endonuclease (red box) and BstXI (green box). For acceptor vectors, I-CeuI is the homing endonuclease of choice, and for donor vectors PI-SceI. The plasmid vector harboring the GOI1-cassette only needs to be linearized with BstXI. The homing endonucleases produce cohesive ends that are compatible with the ends generated by the BstXI digest. Upon insertion of GOI2 into the target vector, a homing endonuclease/BstXI hybrid restriction site is created that cannot be cut by either enzyme (crossed-out red/green box) while the 3'-BstXI site is regenerated. The same procedure can be repeated over and over as exemplified by the integration of GOI3. This cycling logic can be used to generate multigene assemblies. Note that the promoters and terminators are not explicitly shown for reasons of clarity.

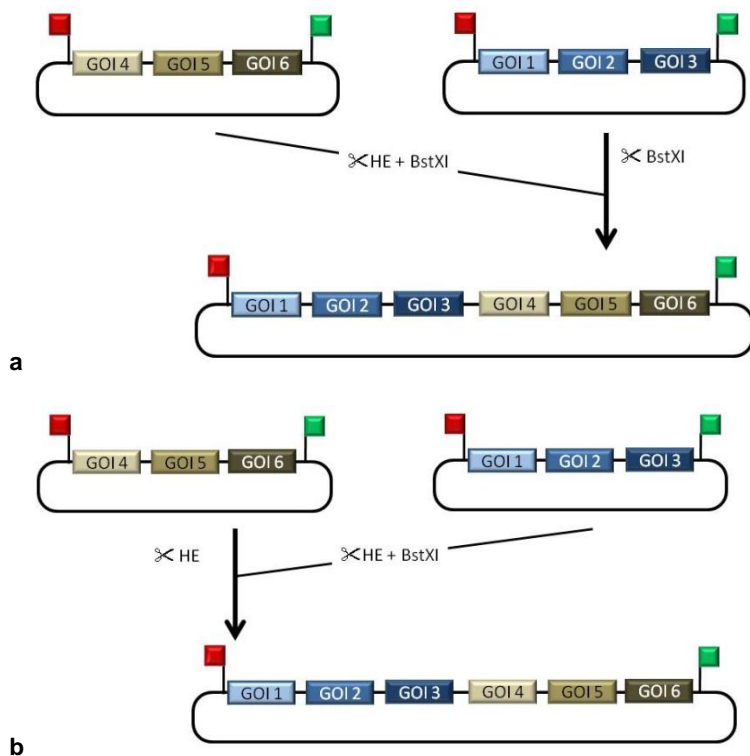
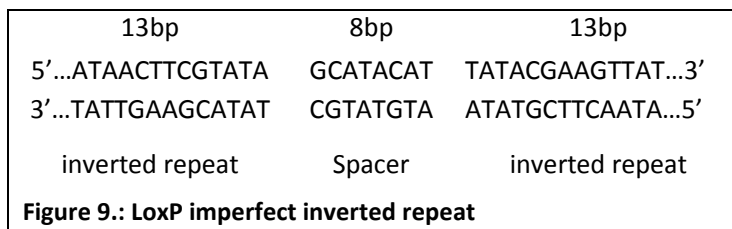

Figure 8. Combining multigene expression cassettes. Different multigeneexpression cassettes can be combined into one expression construct following the same logic that applies to the generation of multigeneexpression cassettes from individual gene cassettes (Figure 4). The 5' homing endonuclease recognition site (filled red box) will be preserved if GOI1 has been introduced by conventional restriction cloning into the MCS. Promoters and terminators are not explicitly shown for reasons of clarity but flank the GOIs in every individual gene expression cassette.

C.2.2. Multigene construction using Cre-Lox recombination

Cre recombinase is a member of the integrase family (Type I topoisomerase from bacteriophage P1). It recombines a 34 bp loxP site in the absence of accessory protein or auxiliary DNA sequence. The loxP site is comprised of two 13 bp recombinase-binding elements arranged as inverted repeats which flank an 8 bp central region where cleavage and the ligation reaction occur.

The site-specific recombination mediated by Cre recombinase involves the formation of a Holliday junction (HJ). The recombination events catalyzed by Cre recombinase depend on the location and relative orientation of the loxP sites. Two DNA molecules, for example an acceptor and a donor plasmid, containing single loxP sites will be fused. Furthermore, the Cre recombination is an equilibrium reaction with 20-30% efficiency in recombination. This provides useful options for multigenecombinations for multi-protein complex expression.



In a reaction where several DNA molecules such as donors and acceptors are incubated with Cre recombinase, the fusion/excision activity of the enzyme will result in an equilibrium state where single vectors (educt vectors) and all possible fusions coexist. Donor vectors can be used with acceptors and/or donors, and vice versa. Higher order fusions are also generated where more than two vectors are fused. This is shown schematically in Illustration 6.

The fact that Donors contain a conditional origin of replication that depends on a *pir*⁺ (*pir* positive) background now allows for selecting out from this reaction mix all desired Acceptor-Donor(s) combinations. For this, the reaction mix is used to transform *pir* negative strains (TOP10, DH5 α , HB101 or other common laboratory cloning strains). Then, Donor vectors will act as suicide vectors when plated out on agar containing the antibiotic corresponding to the Donor encoded resistance marker, unless fused with an Acceptor. By using agar with the appropriate combinations of antibiotics, all desired Acceptor-Donor fusions can be selected for.

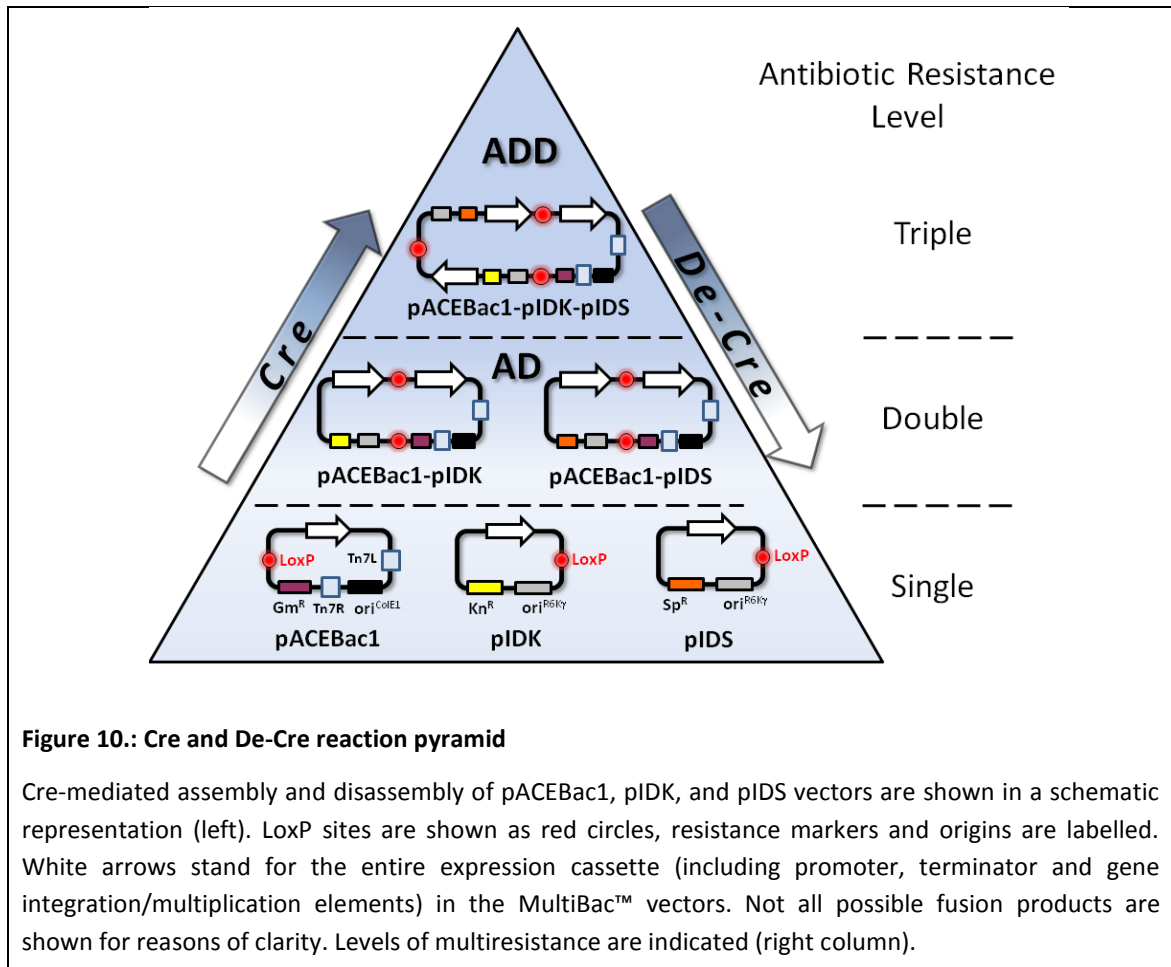

Figure 10.: Cre and De-Cre reaction pyramid

Cre-mediated assembly and disassembly of pACEBac1, pIDK, and pIDS vectors are shown in a schematic representation (left). LoxP sites are shown as red circles, resistance markers and origins are labelled. White arrows stand for the entire expression cassette (including promoter, terminator and gene integration/multiplication elements) in the MultiBac™ vectors. Not all possible fusion products are shown for reasons of clarity. Levels of multiresistance are indicated (right column).

C.2.3. Combining HE/BstXI cycling and Cre-Lox recombination

Of course, both methods can also be combined to generate multiple gene-expression cassette constructs. To this end, you can introduce multiple gene cassettes with the homing endonuclease/BstXI protocol into different Acceptor/Donor vectors and then fuse these using the Cre-Lox modules.

C.3. Baculovirus engineered for improved protein production.

During heterologous protein production using other commercially available baculovirus expression system, viral-dependent proteolytic breakdown consistent with the action of a cysteine protease can be observed. The MultiBac™ baculovirus genome (schematically shown in Figure 11) was modified to yield improved protein production properties. Two baculoviral genes, *v-cath* and *chiA*, have been disrupted which leads to improved maintenance of cellular compartments during infection and protein production. The *v-cath* gene (Slack et al., 1995) encodes for a viral cathepsin-type cysteine protease, V-CATH, which is activated upon cell death by a process that depends on a juxtaposed gene on the viral DNA, *chiA*, which encodes for a chitinase (Hawtin et al., 1995; Hom and Volkman, 2000). Both are involved in the liquefaction of the host insect cells (Slack et al., 1995; Hawtin et al., 1997).

Disruption of both genes served to a) eliminate V-CATH activity and b) to enable chitin-affinity chromatography for purification without interference from the *chiA* gene product. The quality of proteins produced by the MultiBac™ baculovirus is significantly improved through a reduction of virus-dependent proteolytic activity and reduced cell lysis. The disrupted viral DNA sequence was replaced with a LoxP sequence for *cre-lox* site-specific recombination. Note that this LoxP site is not used for introduction of the target constructs into MultiBac™. Instead, the genes of interest are transferred to the bacmid via transposition into the mini Tn7 attachment site. Successful integration results in disruption of the *lacZ*α subunit-coding sequence. As a consequence, clones carrying inserted DNA will appear white.

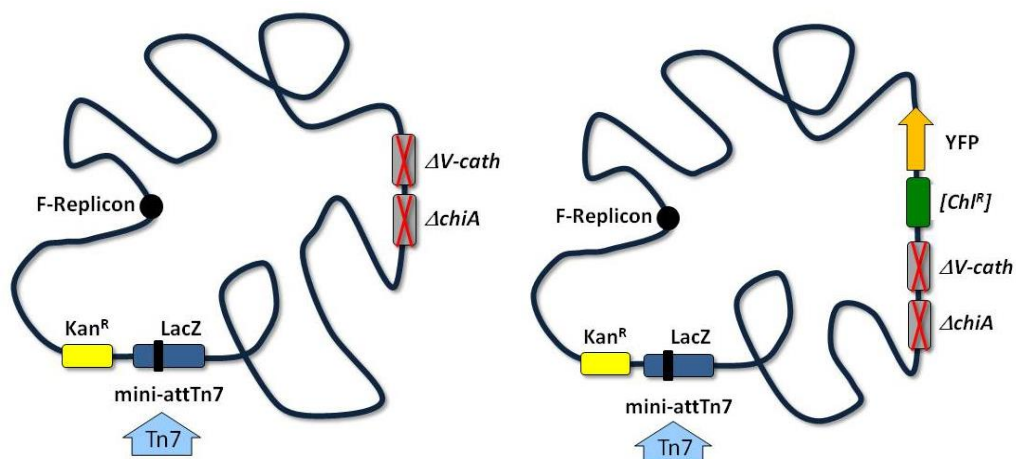

Figure 11.: DH10MultiBac™ and DH10EMBacY baculoviral DNA. The modified viral genome is shown in a schematic representation. The Tn7 attachment site is located within a *LacZ*α gene; insertion of Tn7 elements from pACEBac derivatives therefore produces a white phenotype when plated on agar containing BluGal and IPTG. The viral genes *v-cath* and *chiA* are disrupted by replacement with an antibiotic marker and a non-functional LoxP sequence (both not shown for reasons of clarity).

C.4. Introducing additional control elements

Protein expression requires certain genetic elements at the DNA and RNA level for it to work efficiently, as exemplified by the Shine-Dalgarno or Kozak sequence in bacterial and vertebrate mRNAs, respectively. Without this ribosome-binding motif, efficient translation of the corresponding mRNAs is compromised. Yet, many genes/mRNAs lack such a consensus sequence motif which is not an absolute must for successful translation.

While the polyhedrin promoter already is one of the strongest promoters known, protein production may in some cases be enhanced by substituting the intrinsic leader with alternative leader sequences in the gene expression cassettes. While there is no guarantee that this will work equally well for all proteins under investigation, several reports suggest the inclusion of such motifs into gene design, e.g. the L21 leader from a lobster tropomyosin cDNA (Sano et al., 2002).

In most cases, though, protein production should work just fine with the promoters provided in the transfer vectors.

D. Protocols

D.0 Introductory remarks

Please note that the bacteria in agar stabs have not been made competent for transformation. If you wish to use them to transform your constructs, you will have to prepare competent cells. This applies specifically to the pirHC and pirLC strains used to maintain and amplify donor constructs. You may follow your preferred protocol for preparing chemically or electrocompetent cells, e.g. Inoue et al. (1990) or variations of this protocol, or standard protocols as described in Current Protocols in Molecular Biology or Sambrook and Russell: Molecular Cloning (3rd edition, 2001, or older versions).

D.1 Cloning into pACEBac or pIDx transfer vectors

Reagents:

Restriction endonucleases

DNA ligase

E. coli competent cells

Antibiotics: Chloramphenicol, Gentamycin, Kanamycin, Spectinomycin

The genes of choice are cloned using standard cloning procedures into the multiple cloning sites MCS (see *Supplementary Information*) of pACEBac1/2 and pIDC, pIDK, pIDS. Ligation reactions for pACEBac derivatives are transformed into standard *E. coli* cells for cloning (such as TOP10, DH5 α , HB101) and plated on agar containing gentamycin (7 μ g/ml). Ligation reactions for pIDx derivatives are transformed into *E. coli* cells expressing the *pir* gene (pirHC and pirLC from this kit – in this case you will need to make the cells electro- or chemically competent first; other strains, e.g. BW23473, BW23474) and plated on agar containing chloramphenicol (pIDC; 25 μ g/ml), kanamycin (pIDK; 50 μ g/ml) or spectinomycin (pIDS; 50 μ g/ml). Correct clones are selected based on specific restriction digestion patterns and DNA sequencing of the inserts.

D.2 Multiplication by using the HE and BstXI sites

MultiBac™ donor vectors contain a recognition site for the homing endonuclease PI-SceI (fig. 3). Upon cleavage, this HE site yields a 3' overhang with the sequence -GTGC. Acceptor vectors contain the

homing endonuclease site I-CeuI (see fig. 2), which upon cleavage will result in a 3' overhang of -CTAA. On acceptors and donors, the respective HE site precedes the MCS (see fig. 2 and 3). The 3' end of the MIE contains a specifically designed BstXI site, which upon cleavage will generate a matching overhang. The basis of this is the specificity of cleavage by BstXI. The recognition sequence of BstXI is defined as CCANNNNN'NTGG (the apostrophe marks the position of the phosphodiester link cleavage). The residues denoted as N can be chosen freely. Donor vectors thus contain a BstXI recognition site with the sequence CCATGTGC'CTGG, and Acceptor vectors contain CCATCTAA'TTGG. The overhangs generated by BstXI cleavage in each case will match the overhangs generated by HE cleavage. Note that Acceptors and Donors have different HE sites.

The recognition sites are not symmetric. Therefore, ligation of a HE/BstXI digested fragment into a HE site of an MultiBac™ vector will be (1) directional and (2) result in a hybrid DNA sequence where a HE halfsite is combined with a BstXI half site (see Figure 5). This site will be cut by neither the HE nor BstXI. Therefore, in a construct that has been digested with a HE, insertion by ligation of HE/BstXI digested DNA fragment containing an expression cassette with one or several genes will result in a construct which contains all heterologous genes of interest, enveloped by an intact HE site in front, and a BstXI site at the end. Therefore, the process of integrating entire expression cassettes by means of HE/BstXI digestion and ligation into a HE site can be repeated iteratively.

D2.1 Protocol 1. Multiplication by using homing endonuclease/BstXI.

Reagents required:

Homing endonucleases PI-SceI, I-CeuI
10x Buffers for homing endonucleases
Restriction enzyme BstXI (and 10x Buffer)
T4 DNA ligase (and 10x Buffer)
E. coli competent cells
Antibiotics

Step 1: Insert preparation

Restriction reactions are carried out in 40 µl reaction volumes, using homing endonucleases PI-SceI (Donors) or I-CeuI (Acceptors) as recommended by the supplier.

Acceptor or donor plasmid ($\geq 0.5 \mu\text{g}$) in ddH ₂ O	32 μl	
10x restriction enzyme buffer	4 μl	
10 mM BSA	2 μl	
PI-SceI (Donors) or I-CeuI (acceptors)	2 μl	ca. 10 U

Reactions are then purified using a PCR extraction kit or by acidic ethanol precipitation, and subsequently digested with BstXI according to the supplier's recommendations.

HE digested DNA in ddH ₂ O	32 μl	
10x restriction enzyme buffer	4 μl	
10 mM BSA	2 μl	
BstXI	2 μl	ca. 20 U

Gel extraction of insert(s):

Processed insert is then purified by agarose gel extraction using commercial kits (Qiagen, MachereyNagel etc). Elution of the extracted DNA in the minimal volume defined by the manufacturer is recommended.

Step 2: Vector preparation

Restriction reactions are carried out in 40 μl reaction volumes, using homing endonucleases PI-SceI (Donors) or I-CeuI (Acceptors) as recommended by the supplier.

Acceptor or donor plasmid ($\geq 0.5 \mu\text{g}$) in ddH ₂ O	33 μl	
10x Restriction enzyme buffer	4 μl	
10 mM BSA	2 μl	
PI-SceI (Donors) or I-CeuI (acceptors)	1 μl	ca. 5 U

Reactions are then purified by PCR extraction kit or acidic ethanol precipitation, and next treated with intestinal alkaline phosphatase according to the supplier's recommendations. Dephosphorylation is performed to minimize vector re-annealing and to increase integration of the insert.

HE digested DNA in ddH ₂ O	17 μl	
10x Alkaline phosphatase buffer	2 μl	
Alkaline phosphatase	1 μl	ca. 10 U

Gel extraction of vector:

Processed vector is then purified by agarose gel extraction using commercial kits (Qiagen, MachereyNagel etc). Elution of the extracted DNA in the minimal volume defined by the manufacturer is recommended.

Step 3: Ligation

Ligation reactions are carried out in 20 µl reaction volumes:

HE/Phosphatase treated vector (gel extracted)	4 µl	
HE/BstXI treated insert (gel extracted)	14 µl	
10x T4 DNA Ligase buffer	2 µl	
T4 DNA Ligase	0.5 µl	150 - 200 c.e. U or 2-4 Weiss U

Ligation reactions are performed at 25°C for 1h or at 16°C overnight.

Step 4: Transformation

Mixtures are next transformed into competent cells following standard transformation procedures.

Ligation reactions for pACEBac1 and pACEBac2 derivatives are transformed into standard *E. coli* cells for cloning (such as TOP10, DH5α, HB101) and, after recovery, are plated on agar containing gentamycin (7 µg/ml).

Reactions for Donor derivatives are transformed into *E. coli* cells expressing the *pir* gene (such as BW23473, BW23474, or PIR1 and PIR2 from Invitrogen and, of course, pirLC and pirHC in this kit) and plated on agar containing chloramphenicol (25 µg/ml, pIDC), kanamycin (50 µg/ml, pIDK), or spectinomycin (50 µg/ml, pIDS).

Step 5: Plasmid analysis

Plasmids are cultured and correct clones selected based on specific restriction digestion and DNA sequencing of the inserts.

D.3 Cre-LoxP reaction of Acceptors and Donors

D 3.1. Protocol 2: Cre-LoxP fusion of Acceptors and Donors

This protocol is designed for generating multigene fusions from Donors and Acceptors by Cre-LoxP reaction.

Reagents:

Cre recombinase (from NEB or self made)

Standard *E. coli* competent cells (*pir*⁻ strain, such as Top10)

Antibiotics

96well microtiter plates

12 well tissue-culture plates (or petri dishes) w. agar/antibiotics

LB medium

1. For a 20µl Cre reaction, mix 1-2 µg of each educt in approximately equal amounts. Add ddH₂O to adjust the total volume to 16-17 µl, then add 2 µl 10x Cre buffer and 1-2µl Cre recombinase (1-2 U).
2. Incubate Cre reaction at 37°C (or 30°C) for 1 hour.
3. Optional: load 2-5 µl of Cre reaction on an analytical agarose gel for examination.

Heat inactivation at 70°C for 10 minutes before gel loading is strongly recommended.

4. For chemical transformation, mix 10-15µl Cre reaction with 200 µl chemically competent cells. Incubate the mixture on ice for 15-30 minutes. Then perform heat shock at 42°C for 45-60 s.

Up to 20 µl Cre reaction (0.1 volumes of the chemically competent cell suspension) can be directly transformed into 200 µl chemical competent cells.

For electrotransformation, up to 2 µl Cre reaction can be directly mixed with 100 µl electrocompetent cells, and transformed by using an electroporator (e.g. BIORAD E. coli Pulser) at 1.8-2.0 kV.

Larger volumes of Cre reaction must be desalted by ethanol precipitation or via PCR purification columns before electrotransformation. The desalted Cre reaction mix should not exceed 0.1 volumes of the electrocompetent cell suspension.

The cell/DNA mixture can be immediately used for electrotransformation without prolonged incubation on ice.

5. Add up to 400 µl of LB (or SOC) medium per 100 µl of cell/DNA suspension immediately after the transformation (heat shock or electroporation).

6. Incubate the suspension in a 37°C shaking incubator overnight or for at least 4 hours (recovery period).

To recover multifusion plasmid containing more than 2 resistance markers, it is strongly recommended to incubate the suspension at 37°C overnight.

7. Plate out the recovered cell suspension on agar containing the desired combination of antibiotics. Incubate at 37°C overnight.

8. Clones from colonies present after overnight incubation can be verified by restriction digestion at this stage (refer to steps 12-16).

This quality control step should be carried out especially in the case that only one specific multifusion plasmid is desired.

For further selection by single antibiotic challenges on a 96 well microtiter plate, continue to step 9.

Several to many different multifusion plasmid combinations can be processed and selected in parallel on one 96 well microtiter plate.

9. For 96 well antibiotic tests, inoculate four colonies from each agar plate with different antibiotic combinations into approx. 500 µl LB medium without antibiotics. Incubate the cell cultures in a 37°C shaking incubator for 1-2 hours.

10. While incubating the colonies, fill a 96 well microtiter plate with 150 µl antibiotic-containing LB medium (following Illustration 7). It is recommended to add coloured dye (positional marker) in the wells indicated.

A typical arrangement of the solutions, which is used for parallel selections of multifusion plasmids, is shown in Illustration 10. The concept behind the 96 well plate experiment is that every cell suspension from single colonies needs to be challenged by all four single antibiotics for unambiguous interpretation.

11. Add 1 µl aliquots of pre-incubated cell culture (Step 9) to the corresponding wells. Then incubate the inoculated 96 well microtiter plate in a 37°C shaking incubator overnight at 180-200 rpm.

Recommended: use parafilm to wrap the plate to avoid drying out.

The remainder of the pre-incubated cell cultures can be kept at 4°C for further inoculations if necessary.

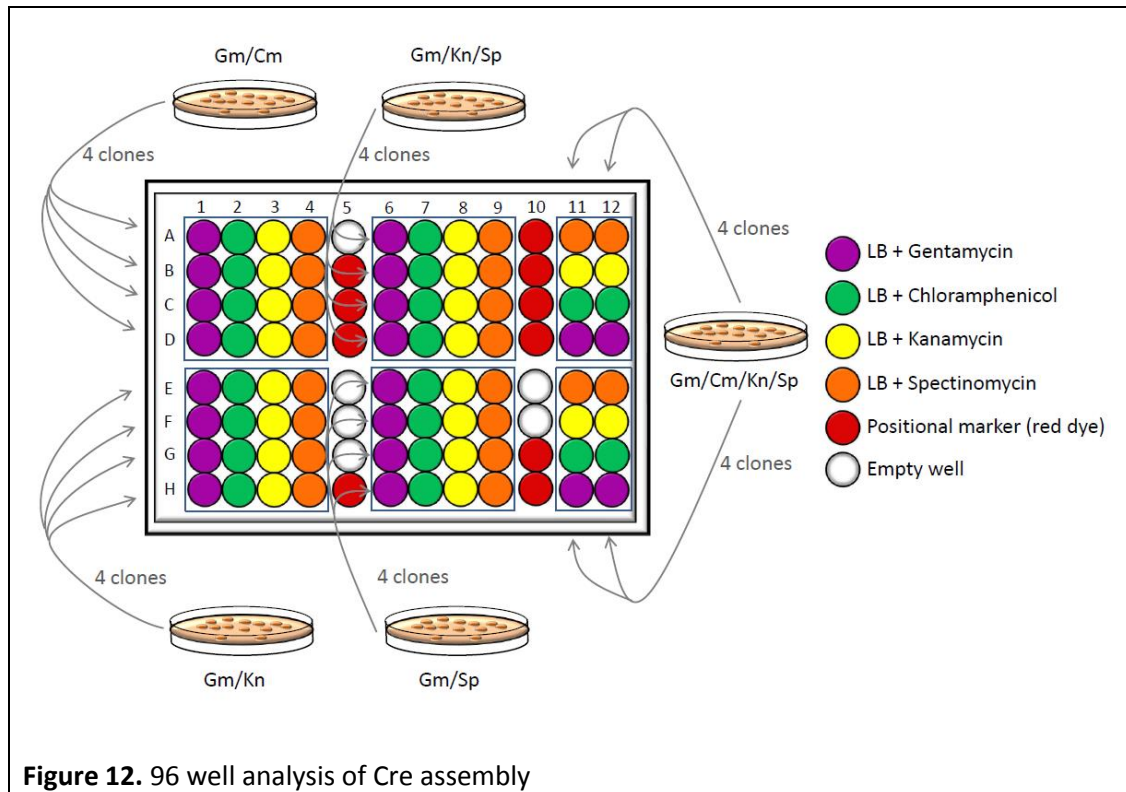
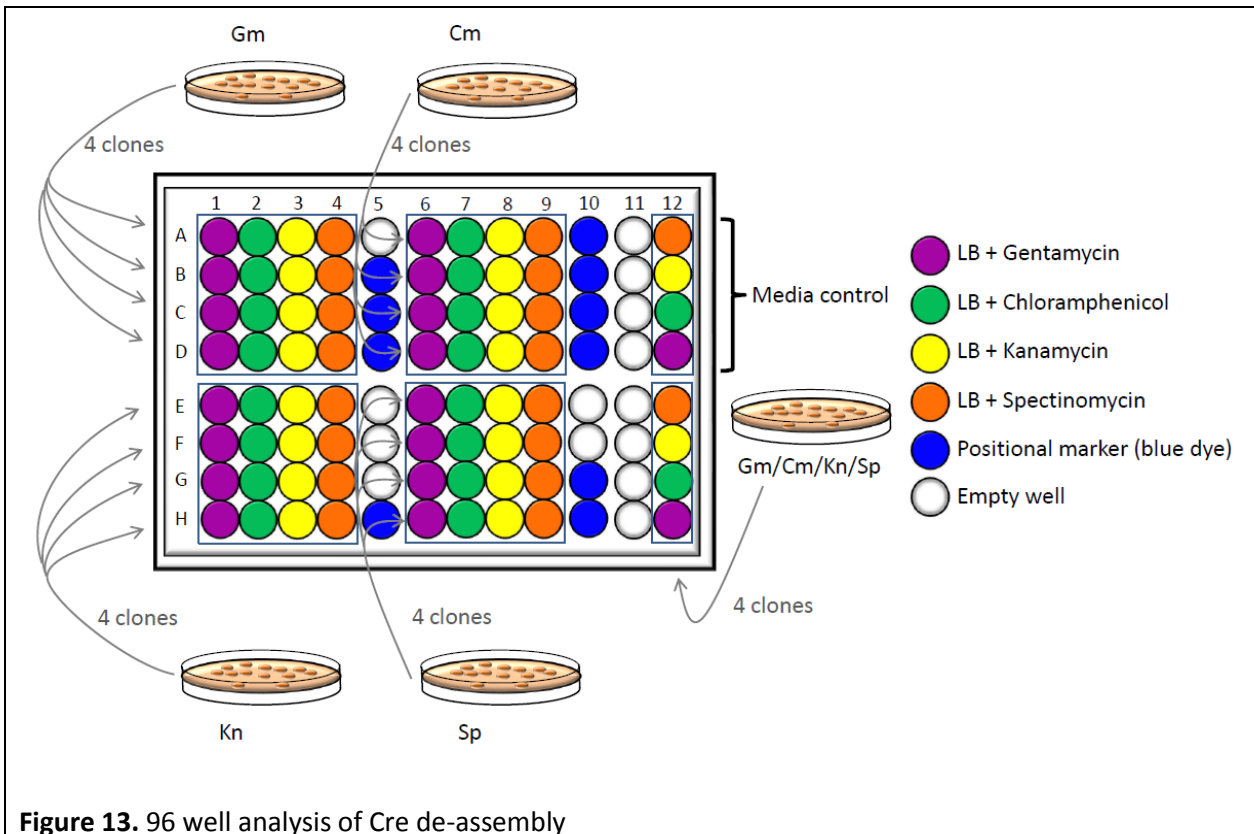

Figure 12. 96 well analysis of Cre assembly

12. Select transformants containing desired multifusion plasmids based on antibiotic resistance, according to the combination of dense (positive) and clear (no growth) cell microcultures from each colony. Inoculate 10-20 μl cell culture into 10 ml LB media with corresponding antibiotics. Incubate in a 37°C shaking incubator overnight.
13. Centrifuge the overnight cell cultures at 4000g for 5-10 minutes. Purify plasmid from the resulting cell pellets with common plasmid miniprep kits, according to manufacturers' recommendation.
14. Determine the concentrations of purified plasmid solutions by using UV absorption spectroscopy (e.g. by using a NanoDrop™ 1000 machine).
15. Digest 0.5-1 μg of the purified plasmid solution in a 20 μl restriction digestion with appropriate endonuclease(s). Incubate under recommended reaction condition for approx. 2 hours.
16. Use 5-10 μl of the digestion for analytical agarose (0.8-1.2%) gel electrophoresis. Verify plasmid integrity by comparing the experimental restriction pattern to a restriction pattern predicted *in silico* (e.g. by using program VectorNTI from Invitrogen or similar programs).

D 3.2. Protocol 3. Deconstruction of fusion vectors by Cre

The following protocol is suitable for releasing any single educt from multifusion constructs (deconstruction). This is achieved by Cre-LoxP reaction, transformation and plating on agar with appropriately reduced antibiotic resistance level (cf. Figure 13). In the liberated educt entity, encoding genes can be modified and diversified. Then, the diversified construct is resupplied by Cre-LoxP reaction (C3.1).



Reagents:

Cre recombinase (and 10x Buffer)

E. coli competent cells

(*pir*⁺ strains, *pir*⁻ strains can be used only when partially deconstructed Acceptor-Donor fusions are desired).

Antibiotics

1. Incubate approx. 1 µg multifusion plasmid with 2 µl 10x Cre buffer, 1-2 µl Cre recombinase, add ddH₂O to adjust the total reaction volume to 20 µl.
2. Incubate this Cre deconstruction reaction mixture at 30°C for 1 to 4 hour(s).

3. Optional: load 2-5 μ l of the reaction on an analytical agarose gel for examination.

Heat inactivation at 70°C for 10 minutes before gel loading is strongly recommended.

4. For chemical transformation, mix 10-15 μ l De-Cre reaction with 200 μ l chemically competent cells. Incubate the mixture on ice for 15-30 minutes. Then perform heat shock at 42°C for 45-60 s.

Up to 20 μ l De-Cre reaction (0.1 volumes of the chemical competent cell suspension) can be directly transformed into 200 μ l chemically competent cells.

For electrotransformation, up to 2 μ l De-Cre reaction can be directly mixed with 100 μ l electrocompetent cells, and transformed by using an electroporator (e.g. BIORAD *E. coli* Pulser) at 1.8-2.0 kV.

Larger volume of De-Cre reaction must be desalted by ethanol precipitation or PCR purification column prior to electrotransformation. The desalted De-Cre reaction mix should not exceed 0.1 volumes of the electrocompetent cell suspension.

The cell/DNA mixture can be immediately used for electrotransformation without prior incubation on ice.

5. Add up to 400 μ l of LB media (or SOC media) per 100 μ l of cell/DNA suspension immediately after the transformation (heat shock or electroporation).
6. Incubate the suspension in a 37°C shaking incubator (recovery).

For recovery of partially deconstructed double/triple fusions, incubate the suspension in a 37°C shaking incubator for 1 to 2 hours.

For recovery of individual educts, incubate the suspension in a 37°C shaking incubator overnight or for at least 4 hours.

7. Plate out the recovered cell suspension on agar containing the desired (combination of) antibiotic(s). Incubate at 37°C overnight.
8. Colonies after overnight incubation can be verified directly by restriction digestion at this stage (refer to steps 12-16).

This is especially recommended in cases where only a single educt or partially deconstructed multifusion plasmid is desired.

For further selection by single antibiotic challenge on a 96 well microtiter plate, continue with step 9.

Several different single educts/partially deconstructed multifusion plasmids can be processed and selected in parallel on one 96 well microtiter plate.

9. For 96 well analysis, inoculate four colonies each from agar plates containing a defined set of antibiotics into approx. 500 μ l LB medium without antibiotics. Incubate the cell cultures in a 37°C shaking incubator for 1-2 hours.

10. While incubating the colonies, fill a 96 well microtiter plate with 150 µl antibiotic-containing LB medium or dye (positional marker) in the corresponding wells.

Refer to Figures 12 and 13 for the arrangement of the solutions in the wells, which are used for parallel selection of single educts or partially deconstructed multifusion plasmids. The concept is that every cell suspension from a single colony needs to be challenged by all four antibiotics separately for unambiguous interpretation.

11. Add 1 µl aliquots from the pre-incubated cell cultures (Step 9) into the corresponding wells. Incubate the 96 well microtiter plate in a 37°C shaking incubator overnight at 180-200 rpm.

Recommended: use parafilm to wrap the plate to prevent desiccation.

The remainder of the pre-incubated cell cultures can be kept at 4°C in a refrigerator for further inoculations if necessary.

12. Select transformants containing desired single educts or partially deconstructed multifusion plasmids according to the combination of dense (growth) and clear (no growth) cell cultures from each colony. Inoculate 10-20 µl from the cell cultures into 10 ml LB media with corresponding antibiotic(s). Incubate in a 37°C shaking incubator overnight.

13. The next day, centrifuge the overnight cell cultures at 4000g for 5-10 minutes. Purify plasmid from cell pellets with common plasmid miniprep kits, according to manufacturers' protocols.

14. Determine the concentrations of purified plasmid solutions by using UV absorption spectroscopy (e.g. NanoDrop™ 1000).

15. Digest 0.5-1 µg of the purified plasmid solution in a 20 µl restriction digestion (with 5-10 units endonuclease). Incubate under recommended reaction condition for approx. 2 hours.

16. Use 5-10 µl of the digestion for analytical agarose gel (0.8-1.2%) electrophoresis. Verify plasmid integrity by comparing the *de facto* restriction pattern to the *in silico* predicted restriction pattern (e.g. by using VectorNTI, Invitrogen, or any other similar program).

17. Optional: Occasionally, a deconstruction reaction is not complete but yields partially deconstructed fusions which still retain entities to be eliminated. In this case, we recommend to pick these partially deconstructed fusions containing and perform a second round of Cre deconstruction reaction (repeat steps 1-8) by using this construct as starting material.

D.4. Transposition protocol for pACEBac derivatives (electrocompetent cells or chemical competent).

Reagents:

Electrocompetent or chemical competent DH10MultiBac™/DH10EmBacY cells

Kanamycin

Tetracyclin

Gentamycin

BluoGal

IPTG

Electroporation: Approximately 5-10 ng of the sequenced pACEBac derivative or of an acceptor-donor fusion is incubated on ice (15 min) with 50-100 µl electro-competent DH10MultiBac™/DH10EMBacY cells. Optimum electroporation settings need to be determined for the equipment used.

Transformation of chemical competent cells: Approximately 100 ng (*maximally 10 µl volume*) of the sequenced pACEBac derivative or of an acceptor-donor fusion is incubated on ice (30 min) with 50-100µl chemical-competent DH10MultiBac™/DH10EMBacY cells. Heat shock is carried out at 42 °C for 15 seconds and the cells are placed again quickly on ice.

Following electroporation or transformation using chemical competent cells, 500 microliters prewarmed SOC media is added to cells. Cells are incubated at 37 °C for 4 hours and plated on agar plates containing kanamycin (50 µg/ml), gentamycin (7 µg/ml), (ampicillin (100 µg/ml)), tetracyclin (10 µg/ml), BluoGal (100 µg/ml) and IPTG (40 µg/ml). We recommend plating a dilution series in SOC or 2XYT media, plating 300 microliters transformed cells on one plate, and plating 30 microliters transformed cells on a second plate.

White colonies are selected after incubation at 37 °C (24 hours). Deeper blue and white color colonies become more visible after leaving the plates for an additional day on the bench at room temperature. Proceed to bacmid preparation for insect cell infection (D.5.).

D.5. Bacmid preparation and infection of insect cells.

Preparation of bacmid DNA, infection of insect cells and protein expression is carried out according to established protocols, e.g. O'Reilly, D.R., Miller, L.K. & Luckow, V.A. "Baculovirus expression vectors. A laboratory manual." Oxford University Press, New York - Oxford, 1994 or David W. Murhammer (ed.). Baculovirus and Insect Cell Expression Protocols, 2nd edition, Methods in Molecular Biology™ 388, Humana Press, Totowa 2007. You may also refer to Fitzgerald et al. (2006), especially pp. 1025-27 and Bieniossek et al. (2008) for protocols on insect cell culture and bacmid preparation.

Large plasmid kits (e.g. Qiagen) can be used to extract recombinant bacmids. Note that precipitation of DNA with isopropanol from cleared lysates is recommended instead of using columns.

D.6. Determining baculoviral expression

As protein expression in the baculoviral system is driven by the late to very late polyhedrin and p10 promoters, onset of protein expression will show some lag and should be expected to start yielding significant amounts at 15 to 24 hrs post-infection. Expression will likely peak at around 40 hrs post-infection but this may vary. Therefore, rapid and reliable methods to determine peak expression are needed. Approaches in use include immunoblot analysis, protein staining techniques or metabolic labeling to chart protein accumulation. Most of these come with a delay due to the necessary handling, e.g. casting gels, preparing protein samples etc.

Expression of target genes from the MultiBac™ bacmid can be determined by SDS-PAGE with or without subsequent Western Blot. Incorporation of tags such as 6xHis (Hexa-His) or FLAG allow purification of proteins and protein complexes. Additionally, you may equip any of your expressed proteins with a reporter protein, e.g. fluorescent proteins such as GFP or YFP.

E. Appendix

E.1. Verifying bacmid integrity in DH10MultiBac™ cells

Streak DH10MultiBac™ cells (from agar stock) on LB plates containing kanamycin (50 µg/ml), tetracycline (10 µg/ml), Bluogal (100 µg/ml) or X-Gal (20 µg/ml) and IPTG (40 µg/ml) and incubate overnight at 37°C. All colonies should turn blue. Note that the dye reaction can take >24 hrs to develop completely. Working stock of bacmid-containing *E.coli* can then be prepared from individual colonies. If, after careful plating, a significant number of colonies show up white, then the stock is likely contaminated and you are advised to re-order bacmid stock (which will be provided free of charge).

E.2. Preparing competent DH10MultiBac™/DH10EMBacY cells

E.2.1 Protocol for electrocompetent cells

Reagents required:

Kanamycin: 50mg/ml stock solution in water (1000x)

Tetracyclin: 12 mg/ml stock solution in 70% EtOH (500x)

BluoGal: 100mg/ml stock (1000x)

IPTG: 0.5M (or 1M) stock (1000x)

Sterile 10% glycerol (mix glycerol with MilliQ water, autoclave)

Protect plates from light, store at 4°C

1. Streak out DH10MultiBac™ or DH10EmBacY cells from frozen stock or agar stab onto an agar plate with antibiotics (Kan, Tet), X-Gal or BluoGal and IPTG.

All colonies must turn BLUE (can take 24 to 30hrs, sometimes longer if the stabs are old). If there are white colonies, the frozen stock is contaminated.

2. Pick one to three blue colonies, prepare a 100mL preculture (make 2 glycerol stocks 30% from preculture) and inoculate 1L LB or 2xTY culture medium adding Kan and Tet as antibiotics. Shake over night at 37 °C or RT.
3. Let culture grow to OD600 = 0.5.

4. Chill 15 min on ice. Pellet by centrifuging at 4000rpm, 4°C, 15min.
5. Resuspend in 500 ml ICE COLD STERILE 10% Glycerol-solution.
6. Centrifuge at 4000rpm, 4°C, 15 min.
7. Resuspend in 250 ml ICE COLD STERILE 10% Glycerol-solution.
8. Centrifuge at 4000rpm, 4°C, 15 min.
9. Resuspend in 50 ml ICE COLD STERILE 10% Glycerol-solution.
10. Centrifuge at 4000rpm, 4°C, 15 min (in 50ml Falcon tube, table top centrifuge).
11. Resuspend in 2 ml ICE COLD STERILE 10% Glycerol-solution.
12. Prepare 100 µl aliquots (in sterile Eppendorf tubes, labeled either MBT or MBY)
13. Flashfreeze in liquid nitrogen, store at –70°C
14. Test cells by streaking out (!!) from one frozen aliquot on agar plate containing antibiotics Kan, Tet plus X-Gal or BluoGal/ IPTG.
All colonies must be BLUE (can take 24 to 30 hrs). If there are white colonies, the competent cells are unusable and must be made anew.
15. Test one frozen aliquot by „blank“ electroporation (1.8kV) – actual kV should be 4-4.5 or more.

You may also want to take a look at other protocols, e.g. the protocol in Sambrook and Russell's Molecular Cloning: A Laboratory Manual or the protocol for enhanced electrotransformation efficiency by Wu et al. in the Electronic Journal of Biotechnology.

E.2.2 Protocol for chemically competent cells

Aside from the protocol provided below, there are numerous protocols for preparing competent cells for heat-shock transformation, e.g. the classical CaCl₂ method, the TSS protocol (originally by Chung et al., 1989, PNAS USA, Vol. 86, pp. 2172-2175), etc.

You will find various protocols online, e.g.

http://francois.schweisguth.free.fr/protocols/TSS_competent_cell_preparation.pdf;

http://www.personal.psu.edu/dsg11/labmanual/DNA_manipulations/Comp_bact_by_TSS.htm;

http://openwetware.org/wiki/Preparing_chemically_competent_cells

or in Sambrook and Russell.

Preparing competent *E.coli* (TOP10) cells with the CaCl₂ method

1. Grow *E.coli* strain by streaking on LB agar plates; incubate o/n at 37 ° C
2. Grow a few colonies in 20ml LB at 37 ° C o/n (to OD 600=1.8)
3. Culture 13ml into 100ml freshly prepared LB (to OD 600 = 0.25)
4. Incubate at 37 ° C on a shaker (180 rpm) for 1 hour (OD600=0.5-0.6, depending on the strain)
5. Distribute the culture into 50ml centrifuge tubes and centrifuge at 8000 rpm, 4 ° C for 5 min (or, alternatively, in 50 ml Falcon tubes, spin at -4000rpm for 6 min)
6. Discard the supernatant completely; then add 10ml of ice cold 0.1M CaCl₂ (keep the cells on ice and resuspend gently)
7. Incubate the solution on ice for 15 min, then centrifuge at 8000 rpm at 4 ° C for 5 min (or, alternatively, in 50 ml Falcon tubes, spin at -4000rpm for 6 min)
8. Remove the supernatant completely and let the pellet air dry
9. Add 2.8ml ice cold 0.1M CaCl₂ and mix gently. Keep on ice till use **OR**
10. Add 1.2 ml of sterile ice cold 80% glycerol to a tube with 2.8ml cells each and mix gently; transfer 100 µl aliquots into sterile 1.5 ml Eppendorf microcentrifuge tubes (use gloves and Bunsen burner flame); keep the Eppendorfs in ice until snap-freezing the bacterial cells in liquid N₂; store at -80°C. **Alternatively**, transfer 100 µl aliquots into sterile 1.5 ml Eppendorfs, add 32 µl of 80% glycerol , freeze in dry ice/EtOH bath or liquid N₂ and store at -80°C.

E.3. Preparing bacterial stocks from agar stabs

We recommend preparing your personal bacterial stock from the agar stabs you received in the kit or transforming your laboratory strain of choice with the vectors (please note that for the donor vectors this needs to be a pir⁺ strain). This is advisable since agar stabs only have a limited shelf life (3-12 months depending on storage conditions). Permanent cultures in glycerol or DMSO, on the other side, should yield viable colonies even after 1 year and beyond if properly stored.

To generate your bacterial stock for long-term storage, streak bacteria from the agar stab onto an appropriate selective plate (refer to the vector maps for acceptor and donor vectors) or plates without antibiotics (pir^{HC} and pir^{LC} strains; we recommend to test these strains against a panel of antibiotics to be on the safe side; no growth of colonies should be observed under conditions of antibiotic selection). Incubate the plates over night at 37°C and then proceed to prepare stocks from

individual colonies for long-term storage according to your protocol of choice (glycerol, DMSO, etc.), as described, for example, in Inoue et al. (1990), Molecular Cloning (Sambrook and Russell, 2000), Current Protocols in Molecular Biology (Ausubel et al., 1994), etc.

E.4. MultiBac™ vectors: maps, sequences, restriction

Note: All acceptor and donor vector sequences can be provided in electronic format. These sequences contain all relevant information such as unique restriction sites, oris, resistance markers, etc. that is also shown in the circle maps. Request your set of vector files and accompanying files from Geneva Biotech at contact@geneva-biotech.com.

In the next section, the acceptor and donor vectors are presented as circle maps and, in addition, the multiple cloning site (MCS) of each vector is shown featuring important unique restriction sites. Moreover, you will find, for the purposes of designing a restriction strategy, a non-exhaustive list of restriction endonucleases that cut once, twice or not at all. Additional restriction sites can be identified with any sequence analysis software, e.g. VectorNTI, ApE, etc. or by using online tools such as WebCutter 2.0 (<http://rna.lundberg.gu.se/cutter2>) or the NEB cutter V2.0 (<http://tools.neb.com/NEBcutter2/>).

Finally, for verifying vector identity, representative digestion patterns are listed in a table.

E.4.1 Acceptor vectors

E.4.1.1 pACEBac1: 2904 bp

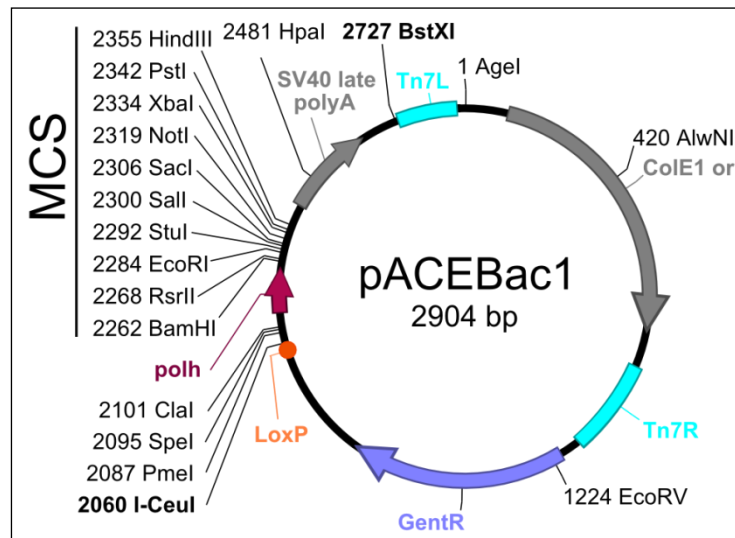

Multiple Cloning Site

AatI

BamHI RsrII BssHII EcoRI StuI Sali SacI

CGGGCGCGGATCCCGGTCCGAAGCGCGCGGAATTCAAAGGCCTACGTCGACGAGCTCACTTGT

NotI BstBI XbaI PstI HindIII

CGCGGCCGCTTTTGAATCTAGAGCCTGCAGTCTCGACAAGCTTGTCGAGAAGTACTAGAGGA

Enzymes that cut pACEBac1 once

2294	AatI	1	Age I	520	AlwNI	2127	Asel, AsnI
1629	AspI	2715	AvrII	2262	BamHI , BstI	2310	BanII
2619	BclI	1307	BsaAI	2102	Bsp106I, BspXI	2277	BssHII
2329	BstBI	2744	BstXI	2075	Bsu36I	2102	Clal
2284	EcoRI	1226	EcoRV	890	FspI	2355	HindIII
2483	HpaI	2470	MfeI	1111	MscI, MluNI	2320	NotI
2109	NruI	2090	PmeI	2346	PstI	114	RcaI
2269	RsrII	2310	SacI	1169	SacII	2300	Sall
2370	Scal	2095	SpeI	2294	StuI	2334	XbaI

Bold type: restriction enzymes cutting in the MCS

Enzymes that cut pACEBac1 twice

2301, 2722	AccI	949, 1418	BglII	2118, 2228	BseAI, BsiMI
2470, 2569	BsmI	1169, 2320	BstZI	2118, 2228	MroI
2125, 2225	SspI				

Enzymes that do not cut pACEBac1

Acc65I	AflII	Apal	BclI	BglI	BstEI	EcoNI	MluI
NaeI	NarI	NcoI	NdeI	NheI	NsiI	PvuI	SfiI
Smal/XmaI	SnaBI	SphI	XcmI	XhoI	XmnI		

Sequence

5' –

```
accggttgacttgggtcaactgtcagaccaagtttactcatatatacttttagattgatttaaaacttcattt
ttaatttaaaaggatctaggtgaagatcctttttgataatctcatgaccaaaatcccttaacgtgagtttc
gttccactgagcgtcagacccccgtagaaaagatcaaaggatcttcttgagatccttttttctgcgcgtaat
ctgctgcttgcaaacaaaaaaaccaccgctaccagcggtggtttgtttgccgatcaagagctaccaactct
ttttccgaaggtaactggcttcagcagagcgcagataccaaatactgttcttctagtgtagccgtagttagg
ccaccacttcaagaactctgtagcaccgcctacatacctcgctctgctaatacctgttaccagtggtgctgc
cagtgggcgataagtcgtgtcttaccgggttgactcaagacgatagttaccggataaggcgcagcggtcggg
ctgaacggggggttcgtgacacagcccagcttggagcgaacgacctacaccgaactgagatacctacagcg
tgagctatgagaaagcggccacgcttcccgaagggagaaaaggcggacaggtatccggttaagcggcagggtcgg
aacaggagagcgcacaggggagcttccagggggaaacgcctggtatctttatagtcctgtcgggtttcgcca
cctctgacttgagcgtcgatttttgtgatgctcgtcagggggcggagcctatggaaaaacgccagcaacgc
ggcctttttacgggttctggccttttctgctggccttttctcacatgttctttctgctgttatccccctgattg
acttgggtcgctcttctgtggatgcgcagatgccctgcgtaagcgggtgtgggaggacaataaagtcttaa
actgaacaaaatagatctaaactatgacaataaagtcttaaaactagacagaatagttgtaaactgaaatcag
tccagttatgctgtgaaaaagcatactggacttttgttatggctaaagcaaactcttcattttctgaagtgc
aaattgcccgctgatttaaagaggggctggccaagggcatgtaaaagactatattcgcggcgttgtgacaat
ttaccgaacaactccgcggccgggaagccgatctcggcttgaacgaattgttaggtggcggtaacttgggtcg
atatcaaagtgcatcacttcttcccgtatgcccaactttgtatagagagccactgcgggatcgtcaccgtaa
tctgcttgacgtagatcacataagcaccaagcgcgttggcctcatgcttgaggagattgatgagcgcggtg
gcaatgccctgcctccggtgctcgcgggagactgagagatcatagatatagatctcactacgcggtgctca
aacttgggcagaacgtaagccgcgagagcgccaacaaccgcttcttggtcgaaggcagcaagcgcgatgaat
gtcttactacggagcaagttcccagggtaatcggagtcgggctgatgttgggagtaggtggctacgtctccg
aactcacgaccgaaaagatcaagagcagcccgatggatttgacttggtcagggccgagcctacatgtgca
atgatgcccatacttgagccacctaactttgttttagggcgactgccctgctgcgtaacatcgttgcgtgctg
cgtaacatcgttgcgtgctccataaacatcaaacatcgacccacggcgtaacgcgcttgcgtgcttggatgcccg
aggcatagactgtacaaaaaacagtcataacaagccatgaaaaccgccaactgcgcccgttaccaccgctgcg
ttcgggtcaaggttctggaccagttgctgtagcgcatacgtacttgcattacagtttacgaaccgaacaggc
ttatgtcaactgggttcgtgccttcatccgtttccacgggtgtgcgtcaccggcaaccttgggcagcagcga
agtcgccataacttcgtatagcatacattatacgaagttatctgtaactataacggtcctaaggtagcgagt
ttaaactagtagatcgattcgcgacctaactccggaatattaatagatcatggagataattaaaaatgataacc
atctcgcaataaataagtattttactgttttctgtaacagttttgtaataaaaaaacctataaatattccgg
attattcataccgtcccaccatcggggcgcggatcccgggtccgaagcgcgcggaattcaaaggcctacgtcga
cgagctcacttgtcgcggccgctttcgaatctagagcctgcagtctcgacaagcttgtcgagaagtactaga
ggatcataatcagccataccacattttagtagaggttttacttgcttataaaaaacctcccacacctccccctga
acctgaaacataaaaatgaatgcaattgttggttgtaacttgtttattgagcttataatgggttacaataaaa
gcaatagcatcaciaaatttcaciaaataaagcattttttcactgcattctagttgtgggttgcctcaaaactca
tcaatgtatcttatcatgtctggatctgatcactgctttagcctagaagatccggctgctaacaagcccga
aaggaagctgagttggctgctgccaccgctgagcaataactatcataaccctagggtatacccatctaatt
ggaaccagataagtgaaatctagttccaaactattttgcatttttaattttcgtatttagcttacgacgcta
caccagttcccactctattttgcactcttccctaaataatccttaaaaaactccatttccaccctcccagt
tcccactattttgcgccca-3'
```

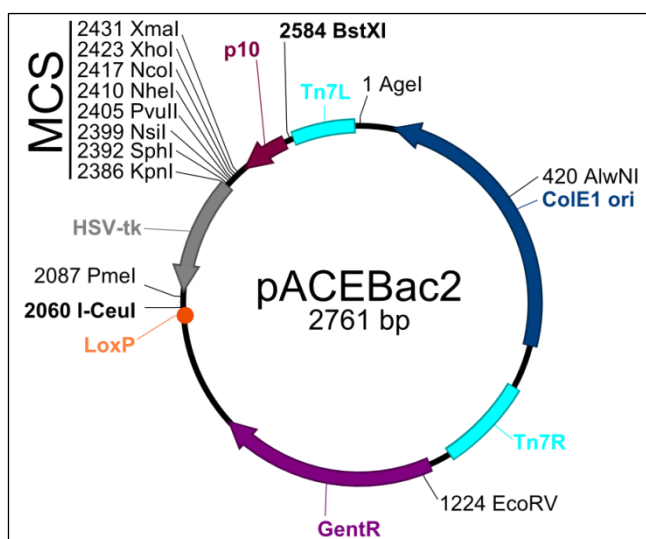
E.4.1.2 pACEBac2: 2761 bp

Multiple Cloning Site

KpnI PaeI NheI
 Acc65I SphI NsiI PvuII

CCGTGTTTTCAGTTAGCCTCCCCATCTCCCGGTACCGCATGCTATGCATCAGCTGCTAGCA

NcoI XhoI XmaI BclI BbsI (-)
 CCATGGCTCGAGATCCCGGTGATCAAGTCTTCGTCGAGTGAT

Enzymes that cut pACEBac2 once

2386	Acc65I	1	Age I	425	AlwNI	2496	AseI, AsnI
1629	AspI	2146	BanII	2444	BbsI (-)	2437	BclI
2223	BsaI	666	BsiI	1582	BsmBI	2591	BstXI
1169	BstZI, EagI KspI	2075	Bsu36I	1226	EcoRV	2390	KpnI
1111	MluNI, MscI	2417	NcoI	2410	NheI	2403	NsiI
2090	PmeI	2407	PvuII	114	RcaI	1169	SacII
2433	SmaI, XmaI	2396	SphI	2423	XhoI		

Bold type: restriction enzymes cutting in the MCS (-) cutting on the negative strand

Enzymes that cut pACEBac2 twice

2569, 2579	AccI	949, 1418	BglII	312, 1077	Eco57I
594, 1471	Haell	464, 1546	HinfI		

Enzymes that do not cut pACEBac2

AatII	AflII	Apal	AscI	AvrII	BamHI	BclI	BglI
-------	-------	------	------	-------	-------	------	------

BssHII	Clal	Drall	EcoNI	EcoRI	HpaI	MfeI	NaeI
NarI	NdeI	NotI	NruI	PstI	PvuI	RsrII	SacI
Sall	SbfI	Scal	SfiI	SnaBI	SpeI	StuI	XbaI
XcmI	XmnI						

Sequence

5' -

accggttgacttgggtcaactgtcagaccaagtttactcataataacttttagattgatttaaaacttca
tttttaatttaaaaggatctaggtgaagatcctttttgataatctcatgaccaaactccttaacgtga
gttttcgttccactgagcgtcagaccccgtagaaaagatcaaaggatccttcttgagatccttttttct
gcgcgtaactctgctgcttgcaaacaaaaaaccaccgctaccagcgggtggtttggttgccggatcaaga
gctaccaactcctttttccgaaggtaactggcttcagcagagcgcagataccaaatactggttcttctagt
gtagccgtagtttaggccaccacttcaagaactctgtagcaccgcctacatacctcgtctgctaactct
gttaccagtggtgctgctgccagtgccgataagtcgtgcttaccgggttgactcaagacgatagttacc
ggataaggcgcagcggctcgggctgaacgggggggttcgtgcacacagcccagcttgagcgaacgaccta
caccgaactgagatacctacagcgtgagctatgagaaagcggcagcttcccgaagggagaaaggcggga
caggatccggtaagcggcagggctcggaacaggagagcgcacgagggagcttccagggggaaacgctg
gtatctttatagtcctgtcgggtttcgccacctctgacttgagcgtcgatttttgtgatgctcgtcagg
ggggcggagcctatggaaaaacgcccagcaacgcggcctttttacgggttcctggccttttgctggccttt
tgctcacatggttctttcctgcttatcccctgattgacttgggtcgtctctcctgtggatgctcagatg
ccctgctgaagcgggtgtgggcggacaataaagtcttaaaactgaacaaaatagatctaaactatgacaa
taaagtcttaaaactagacagaaatagttgtaaactgaaatcagtcagttatgctgtgaaaaagcatact
ggacttttggtatggctaaagcaaactcttcattttctgaagtgcaaattgcccgctgattaaagagg
ggcgtggccaagggcatgtaaagactatattcgcggcgttgtagacaatttaccgaacaactccgcggcc
gggaagccgatctcggcttgaacgaattggttaggtggcggtaacttgggtcgatatcaaagtgcatact
tcttcccgtatgcccactttgtatagagagccactgcgggatcgtcaccgtaactctgcttgcacgtag
atcacataagcaccaagcgcgttggcctcatgcttgaggagattgatgagcgcgggtggcaatgccctgc
ctccggtgctcgcgggagactgcgagatcatagatatagatctcactacgggctgctcaaacttgggc
agaacgtaagccgcgagagcgcacaacccgcttcttgggtcgaaggcagcaagcgcgatgaatgtctta
ctacggagcaagttcccgaggtaatcggagtcgggctgatgttgggagtaggtggctacgtctccgaac
tcacgaccgaaaagatcaagagcagcccgcattgacttgggtcagggccgagcctacatgtgcga
atgatgccatacttgagccacctactttgttttagggcgactgccctgctgcgtaacatcgttgcg
ctgcgtaacatcgttgcgctccataacatcaaacatcgaccacggcgtaacgcgcttgctgcttggga
tgcccgaggcatagactgtacaaaaaacagtcataacaagccatgaaaaccgcccactgcccgttacc
accgctgcgttcgggtcaaggttctggaccagttgctgagcgcatacgtacttgcatcagtttacg
aacccaagcggcttatgtcaactgggttcgtgccttcatccgtttccacgggtgctgcgtcaccggcaac
cttgggcagcagcgaagtgcgcataacttctgatagcatacattatacgaagttatctgtaactataac
ggctcctaaggtagcaggtttaaactgaccgtagtggtatggcagggcttgcggcccgcgcttggct
gagcagcctgggccttaccggaacttgggggttgggggtgggaaaaggaagaaacgcggggcgtattgg
tcccgaatgggtctcgggtgggtatcgacagagtgccagccctgggaccgaaccccgctttatgaaca
aacgaccaacaccgctgcgttttattctgtctttttattgccgctcatagcgcgggttccttccggat
tgtctccttccgtgtttcagtttagcctccccatctcccggtaaccgatgctatgcatcagctgctagc
accatggctcgagatcccgggtgatcaagtcttctgcgagtgattgtaataaaaatgtaatttacagta
tagtatttttaattaataatacaaatgatttgataataattcttattttaactataatataattgtgttgggt
tgaattaaaggtccgtatactagggtatacccatctaattggaaccagataagtgaatctagttccaa
actattttgcatttttaattttcgtatttagcttacgacgctacaccagttcccactattttgcac
tcttccctaataatccttaaaaactccatttccaccctcccagttcccactattttgcgcccac
a-3'

E.4.2 Donor vectors

E.4.2.1 pIDC: 2312 bp

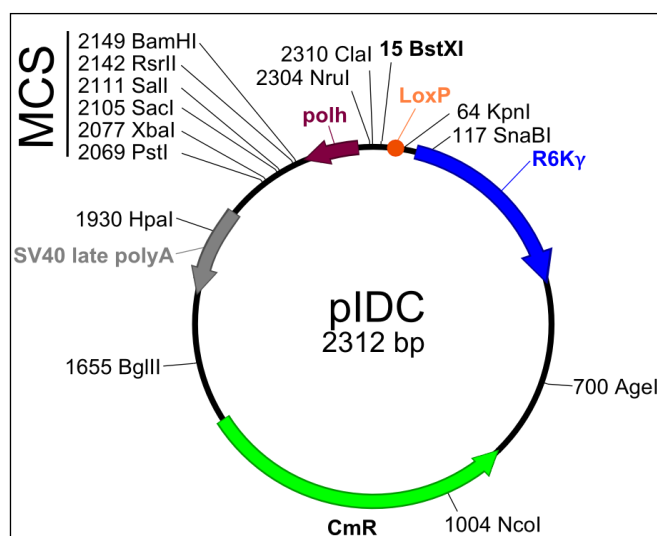

Multiple Cloning Site

```

                                 PstI     XbaI                                     SacI
TTCTCGACAAGCTTGTCTGAGACTGCAGGCTCTAGATTTCGAAAGCGGCCGCGACTAGTGAGCTC
    
```

```

AccI     AatI
Sali     StuI                     BssHII   RsrII   BamHI
GTCGACGTAGGCCTTTGAATTCCGCGCGCTTCGGACCGGGATCCGCGCCCGATGGTGGGACGG
    
```

Enzymes that cut pIDC once

2121	AatI	64	Acc65I	700	Age I	760	AspI
1696	AvrII	2149	BamHI	2109	BanII	1655	BglII
2134	BssHII	2149	BstI (BamHI)	15	BstXI	650	Bsu36I
2310	ClaI	1930	HpaI	64	KpnI	1941	MfeI
1040	MscI, MluNI	1004	NcoI	2304	NruI	2069	PstI
2142	RsrII	2105	SacI	68	SacII	2111	Sall
117	SnaBI	2119	SseBI, StuI	2109	SstI	2077	XbaI

Bold type: restriction enzymes cutting in the MCS

Enzymes that cut pIDC twice

281, 2285	AseI, AsnI	766, 2108	BstBI	70, 2090	BstZI, EagI
1305, 2127	EcoRI	359, 2056	HindIII	70, 2090	NotI
580, 1407	PvuII	890, 2043	Scal	4, 2099	SpeI
1004, 1696	StyI				

Enzymes that do not cut pIDC

AatII	AflII	AlwNI	Apal	Ascl	BclI	BglI	BstZ17I
Drall	EcoNI	EcoRV	Mbol	Mlul	NaeI	NarI	NdeI
NheI	Nsil	PmeI	PvuI	SbfI	SfiI	SmaI	SphI
XcmI	XhoI	XmaI	XmnI				

Sequence

5' -

gatactagtaaaacccatgtgctggcagataacttcgtataatgtatgctatacgaagttatgggtacc
gcgccgcgtagaggatctgttgatcagcagttcaacctgttgatagtagtactaagctctcatgttt
cacgtactaagctctcatgtttaacgtactaagctctcatgtttaacgaactaaacctcatggctaac
gtactaagctctcatggctaacgtactaagctctcatgtttcacgtactaagctctcatgtttgaacaa
taaaattaatataaatcagcaacttaaatagcctctaaggttttaagttttataagaaaaaaagaata
tataaggcttttaagcttttaaggtttaacggttgtggacaacaagccagggatgtaacgcactgaga
agcccttagagcctctcaaagcaattttgagtgcacaggaacacttaacggctgacagaattagcttc
acgctgccgcaagcactcagggcgcaagggctgctaaaggaagcggaaacacgtagaaagccagtcgca
gaaacggtgctgaccccgatgaatgtcagctgggaggcagaataaatgatcatatcgtcaattattac
ctccacggggagagcctgagcaaaactggcctcaggcatttgagaagcacacggtcacactgcttccggt
agtcaataaacggtaaacaccagcaatagacataagcggctatttaacgacctgccctgaaccgacgac
cgggtcgaatgtgctttcgaatcttgcattcatccgcttattatcacttattcaggcgtagcaacca
ggcgtttaagggcaccaataactgccttaaaaaaattacgccccgccctgccactcatcgcagtagtgt
tghtaattcattaagcattctgccgacatggaagccatcaciaacggcatgatgaacctgaatcgccagc
ggcatcagcaccttgctgccttgctataatatttgccatgggtgaaaacggggcgagaagttgtcc
atattggccagtttaaatcaaaactggtgaaactcaccagggattggctgagacgaaaaacatattc
tcaataaaccttttagggaaaataggccagggttttcaccgtaacacgccacatcttgcaatatatgtgt
agaaactgccggaatcgctcgtggtattcactccagagcgatgaaaacgtttcagtttgctcatggaaa
acgggtgaacaaggggtgaacactatcccatatcaccagctcaccgtctttcattgccatacgggaattcc
ggatgagcattcatcaggcgggcaagaatgtgaaataaaggccggataaaaacttgctgcttatttttctt
acggcttttaaaaaggccgtaatatccagctgaacggctctggttataggtacattgagcaactgactga
aatgcctcaaaatgttctttacgatgccattgggatataatcaacgggtggtatatccagtgatttttttc
tccatttttagcttcttagctcctgaaaatctcgataactcaaaaaatacgcccggtagtgatcttatt
tcattatggtgaaagttggaccctcttacgtgcgatcaacgtctcattttcgccaaaagttggcccag
atctatgtcgggtgaggagaaagaggtaatgaaatggcacctaggggttatgatagttattgctcagcg
gtggcagcagccaactcagcttctttcgggctttgtagcagccgatcttctaggctcaagcagtgga
tcagatccagacatgataagatacattgatgagtttggaacaaaccacaactagaatgcagtgaaaaaa
tgctttattttgtgaaatgtgtgatgctattgctttattttgtaaccattataagctgcaataaacaagtt
aacaacaacaattgcattcattttatgtttcagggttcagggggagggtgtgggagggttttttaagcaag
taaaacctctacaaatgtggtatggctgattatgatcctctagtagtctctcgacaagcttgctcgagact
gcaggctctagattcgaaagcggccgcgactagtgagctcgtcgacgtaggcctttgaattccgcgcgc
ttcggaccgggatccgcgcccgatggtgggacggatgaataatccggaatatttatagggtttttttat
tacaaaactgttacgaaaacagtaaaatacttattttatgtcgagatggttatcattttaattatctcc
atgatctattaatattccggagtaggtcgcgaatc-3'

E.4.2.2 pIDK: 2281 bp

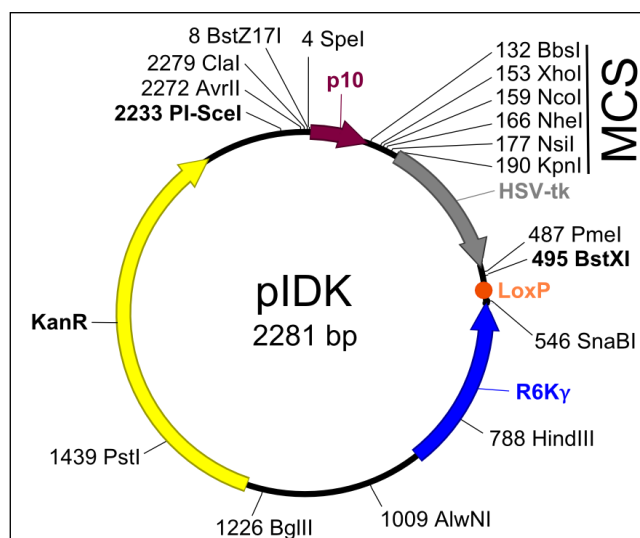

Multiple Cloning Site

BbsI
XhoI
NcoI
NheI

ACAATCACTCGACGAAGACTTGATCACCCGGGATCTCGAGCCATGGTGCTAGCAGCTG

Acc65I

NsiI
KpnI

ATGCATAGCATGCGGTACCGGG

Enzymes that cut pIDK once

190	Acc65I, KpnI	1014	AlwNI	1508	AspI	2272	AvrII, BlnI
132	BbsI	1226	BglII	363	BsaI	1787	BssHII
2072	BstBI	2744	BstXI	1296	BstZI, EagI	8	BstZ171
1492	FspI	788	HindIII	1472	MscI, MluNI	159	NcoI
166	NheI	181	NsiI	490	PmeI	1443	PstI
1906	RsrII	2072	SfuI	548	SnaBI	4	SpeI
1206	XcmI	153	XhoI				

Bold type: restriction enzymes cutting in the MCS

Enzymes that cut pIDK twice

82, 711	Asel, AsnI	1145, 1393	BbeI	139, 1231	BclI
1744, 1954	EarI	1145, 1393	Haell	1892, 2175	NaeI
188, 1795	PaeI	147, 2229	SmaI, XmaI	188, 1795	SphI

Enzymes that do not cut pIDK

AatII	AflII	AgeI	Apal	ApaLI	AscI	BamHI	BglI
Drall	EcoNI	EcoRI	EcoRV	Drall	MboI	MluI	NdeI
PvuI	SbfI	SfiI	StuI	XbaI	XmnI		

Sequence

5' –

gatactagtagtatacggacctttaattcaacccaacacaatatattatagttaaataagaattattatcaa
atcatttgtatattaattaaaatactatactgtaaattacattttatttacaatcactcgcgacgaagact
tgatcaccgggatctcgcagccatgggtgctagcagctgatgcatagcatgcggtaccgggagatggggg
aggctaactgaaacacggaaggagacaataaccggaaggaacccgcgctatgacggcaataaaaagacag
aataaaacgcacgggtgttgggtcgtttgttcataaacgcggggttcgggtcccagggtggcactctgt
cgataccccaccgagaccccatattgggaccaatacgcggcggttcttctctttccccacccccaccccc
aagttcgggtgaaggcccagggtcgcagccaacgtcggggcggaagccctgccatagccactacggg
tacgtttaaacccatgtgcctggcagataacttcgtataatgtatgctatacgaagttaggtacgtac
taagctctcatgtttcagctactaagctctcatgtttaacgtactaagctctcatgtttaacgaactaa
accctcatggctaacgtactaagctctcatggctaacgtactaagctctcatgtttcacgtactaagct
ctcatgtttgaacaataaaaattaataataatcagcaacttaaatagcctctaaggttttaagttttata
agaaaaaaagaatatataaggcttttaagcttttaaggtttaacgggtgtggacaacaagccagggg
tgtaacgcactgagaagcccttagagcctctcaaagcaattttcagtgacacaggaacacttaacggct
gacagaattagcttcacgctgccgcaagcactcagggcgcaagggtgctaaaggaagcggaaacacgta
gaaagccagtcgcgagaaacgggtgctgaccccggatgaatgtcagctactgggctatctggacaagggg
aaacgcaagcgaagagaaagcaggtagcttgcagtgggcttacatggcgatagctagactggggcgt
tttatggacagcaagcgaaccggaattgccagctggggcgccctctggtaagggtgggaagccctgcaa
agtaaacggatggctttcttgcgccaaggatctgatggcgaggggatcaagatctgatcaagagac
aggatgaggatcgtttcgcatgattgaacaagatggattgcacgcaggttctccggccgcttgggtgga
gaggctattcggctatgactgggcacaacagacaatcggctgctctgatgcccggctgttccggctgtc
agcgcaggggccccgggttctttttgtcaagaccgacctgtccggtgccctgaatgaactgcaggacga
ggcagcgcggctatcgtggctggccacgacgggcttccttgcgcagctgtgctcgcaggttgtcactga
agcgggaagggactggctgctattggggaagtgccggggcaggatctcctgtcatctcaccttgctcc
tgccgagaaagtatccatcatggctgatgcaatgcggcggctgcatacgttgatccggctacctgcc
attcgaccaccaagcgaaacatcgcacgcagcgcagcactcggatggaagccggtccttgtcgcata
ggatgatctggacgaagagcatcaggggctcgcgccagccgaactgttcgccaggctcaaggcgcgc
gcccgcagcgcaggatctcgtcgtgacacatggcgatgcttgcgcaatatcatggtggaaaatgg
ccgcttttctggattcatcgcactgtggccggctgggtgtggcggaccgctatcaggacatagcgttggc
taccogtgatattgctgaagagcttggcggcgaatgggctgaccgcttcctcgtgctttacggtatcgc
cgctcccgatcgcagcgcacgccttctatcgccttcttgacgagttcttctgagcgggactctgggg
ttcgaaatgaccgaccaagcgcacgccaacctgccatcacgagatttcgattccaccgccccttctat
gaaaggttgggcttcggaatcgtttccgggacgcccggctggatgatcctccagcgcggggatctcatg
ctggagttcttcgcccaccccggtatctatgtcgggtgcgagaaagaggaatgaaatggcacctagg
tatac-3'

E.4.2.3 pIDS: 2231 bp

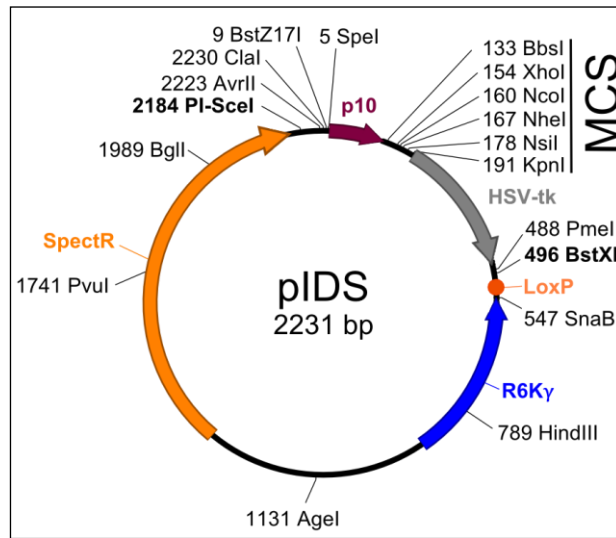

Multiple Cloning Site

SmaI
 BbsI XmaI XhoI NcoI NheI NsiI
 CAATCACTCGACGAAGACTTGGATCACCCGGGATCTCGAGCCATGGTGCTAGCAGCTGATGCAT

Acc65I
 SphI KpnI
 AGCATGCGGTACC

Enzymes that cut pIDS once

191	Acc65I, KpnI	1131	Agel	1638	ApaLI	2223	AvrII, BlnI
133	BbsI	1989	BglII	2087	BssHII	496	BstXI
9	BstZ17I	1081	Bsu36I	2230	ClaI	789	HindIII
2012	NaeI	160	NcoI	167	NheI	178	NsiI
488	PmeI	1741	PvuI	146	SmaI, XmaI	547	SnaBI
5	SpeI	185	SphI	154	XhoI		

Bold type: restriction enzymes cutting in the MCS

Enzymes that cut pIDS twice

82, 711	Asel, AsnI	489, 785	DraI	172, 1011	PvuII
82, 711	VspI				

Enzymes that do not cut pIDS

AatII	AfeI	AlwNI	Apal	AscI	BamHI	BglII	BstBI
Drall	EcoNI	EcoRI	EcoRV	HincII	HpaI	MboI	MluI

MscI	NarI	NdeI	NotI	NruI	PstI	RsrII	SacI
Sall	SbfI	SfiI	StuI	XbaI	XcmI	XmnI	

Sequence

5' –

cgatactagatatacggacctttaattcaacccaacacaatatattatagttaaataagaattattatca
aatcatttgtatattaattaaaatactatactgtaaattacattttattacaatcactcgacgaagac
ttgatcaccggtgatctcgagccatggtgctagcagctgatgcatagcatgcggtaccgggagatgggg
gaggctaactgaaacacggaaggagacaataaccggaaggaacccgcgctatgacggcaataaaaagaca
gaataaaacgcacgggtggtgggtcgtttggtcataaacgcgggggttcgggtcccagggtggcactctg
tcgataccccaccgagacccccattgggaccaatacgcgccggtttcttcttttccccacccaacccc
caagttcgggtgaaggcccagggtcgcagccaacgtcggggcggcaagccctgccatagccactacgg
gtacgtttaaacccatgtgcctggcagataacttcgtataatgtatgctatacgaagttatggtacgta
ctaagctctcatgtttcacgtactaagctctcatgtttaacgtactaagctctcatgtttaacgaacta
aacctcatggctaacgtactaagctctcatggctaacgtactaagctctcatgtttcacgtactaagc
tctcatgtttgaacaataaaaattaataaaatcagcaacttaaatagcctctaaggttttaagttttat
aagaaaaaaaaagaatatataaggcttttaagcttttaaggtttaacggttgtggacaacaagccaggg
atgtaacgcactgagaagcccttagagcctctcaaagcaattttgagtgacacaggaacacttaacggc
tgacataattcagcttcacgctgccgcaagcactcagggcgcaagggctgctaaaggaagcggaacacg
tagaaagccagtcgcgagaaacgggtgctgacccccggatgaatgtcagctgggaggcagaataaatgatc
atatcgtcaattattacctccacggggagagcctgagcaaacctggcctcaggcatttgagaagcacacg
gtcacactgcttccggtagtcaataaacggtaagtagcgtatgctcactcagcaactggtccagaacct
tgaccgaacgcagcgggtggtaacggcgcagtggggttttcatggcttggtatgactgtttttttgggg
tacagtctatgcctcgggcacccaagcagcaagecgttacgccgtgggtcgatgtttgatgttatgga
gcagcaacgatgttacgcagcagggcagtcgcctaaaacaaagttaaacatcatgaggggaagcgggtga
tcgccgaagtatcgactcaactatcagaggtagttggcgtcatcgagcgccatctcgaaccgacgttgc
tggccgtacatttgtacggctccgcagtggtggcggcctgaagccacacagtgatattgatttgcgtgg
ttacggtgaccgtaaggcttgatgaaacaacgcggcgagctttgatcaacgaccttttgaaacttcgg
cttcccctggagagagcgagattctccgcgctgtagaagtcaccattggtgtgacgacgacatcattc
cgtggcggttatccagctaagcgcgaactgcaattttggagaatggcagcgaatgacattcttgcaggta
tcttcgagccagccacgatcgacattgatctggctatcttgctgacaaaagcaagagaacatagcgttg
ccttggtaggtccagcggcggaggaactctttgatccgggtcctgaacaggatctatttgaggcgctaa
atgaaaccttaacgctatggaactcgcgcccgactgggctggcgatgagcgaaatgtagtgcttacgt
tgtcccgcatttgggtacagcgcagtaaccggcaaaaatcgcgccgaaggatgtcgtgcccactgggcaa
tggagcgcctgccggcccagtatcagcccgtcatacttgaagctagacaggcttatcttgacaagaag
aagatcgcttggcctcgcgcgagatcagttggaagaatttgccactacgtgaaaggcgagatcacca
aggtagtcggcaataatgtctaacaattcgttcaagccgacggatctatgtcgggtgcccggagaaagag
gtaatgaaatggcacctaggtat-3'

E.4.3. Analytical restriction digest patterns

All MultiBac™ acceptor and donor vectors yield characteristic restriction digest patterns when plasmid DNA is restricted with HindIII and/or HinfI or a combination of both.

Vector	Length [bp]	Restriction	Fragment(s) [bp]
pACEBac1	2904	HindIII	2904
		HinfI	1082, 1037, 558, 227
pACEBac2	2761	HindIII	2761
		HinfI	1679, 1082
pIDC	2312	HindIII	1697, 615
		HinfI	1125, 960, 227
		HindIII/HinfI	1100, 597, 363, 227, 25
pIDK	2281	HindIII	2281
		HinfI	2000, 134, 58, 52, 37
		HindIII/HinfI	1087, 913, 134, 58, 52, 37
pIDS	2231	HindIII	2231
		HinfI	2018, 213
		HindIII/HinfI	1413, 605, 213

E.4.4 DH10MultiBac™ and DH10EMBacY baculoviral genomes

Both vectors (size approx. 130 kb) are derivatives of the *Autographa californica* nucleopolyhedrovirus (AcMNPV) genome. It has been genetically engineered for improved protein production and reduced protein degradation (details on p. 18). In addition, it contains an element for accepting donor DNA into its transposition acceptor site (mini-attTn7) that concomitantly allows blue-white selection to identify successful transposition events. The bacmid possesses the F replicon from the F plasmid that keeps the plasmid copy number at 1 (single copy).

It is hosted in DH10MultiBac™ *E.coli* cells and can be isolated from the bacteria using commercial “large construct” kits (e.g. Qiagen) or appropriate protocols for preparation of large DNA molecules (e.g. King et al., 2007). Also refer to Chapter D.5 on p. 30.

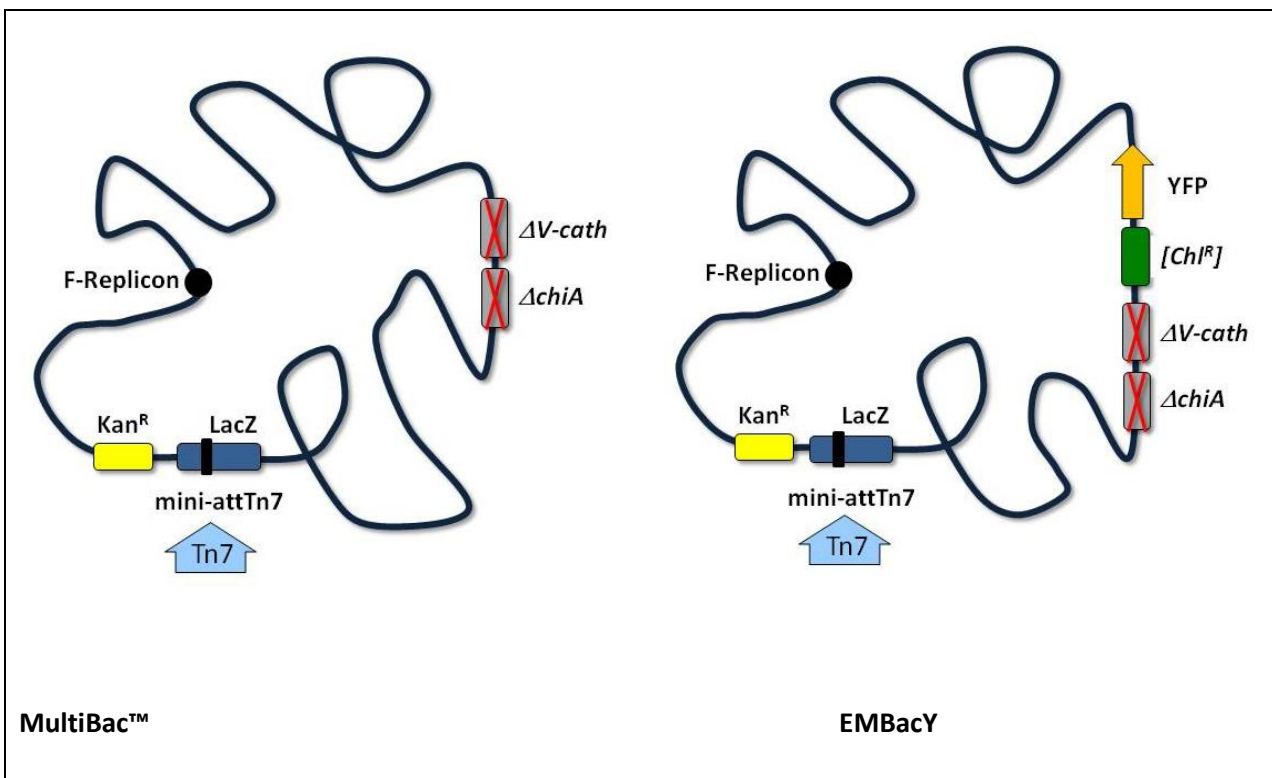

F. References

1. **Ausubel F, Brent R, Kingston RE, Moore DD, Seidman JG, Smith JA, and Struhl K** (eds., 1994). Current Protocols in Molecular Biology. John Wiley & Sons, New York, electronic version DOI 10.1002/0471142727
2. **Bieniossek C et al.** (2008). MultiBac™ : Multigene Baculovirus-Based Eukaryotic Protein Complex Production. *Current Protocols in Protein Science* 51: 5.20.1-26
3. **Charbonnier S et al.** (2008). The social network of a cell: Recent advances in interactome mapping. *Biotechnology Annual Review* 14: 1-28.
4. **Figeys D** (2008). Mapping the human protein interactome. *Cell Research* 18: 716-724.
5. **Fitzgerald DJ et al.** (2006). Protein complex expression by using multigene baculoviral vectors. *Nature Methods* 3: 1121-1132.
6. **Hawtin RE et al.** (1995). Identification and Preliminary Characterization of a Chitinase Gene in the *Autographa californica* Nuclear Polyhedrosis Virus Genome. *Virology* 212: 673-685.
7. **Hawtin RE et al.** (1997). Liquefaction of *Autographa californica* Nucleopolyhedrovirus-Infected Insects Is Dependent on the Integrity of Virus-Encoded Chitinase and Cathepsin Genes. *Virology* 238: 243-253.
8. **Hom LG and Volkman LE** (2000). *Autographa californica* M nucleopolyhedrovirus *chiA* is required for processing of V-CATH. *Virology* 277: 178-183.
9. **Inoue H, Nojima H and Okayama H** (1990). High efficiency transformation of *Escherichia coli* with plasmids. *Gene* 96: 23-28.
10. **King L, Hitchman R, and Possee RD** (2007). Recombinant Baculovirus Isolation. In: Murhammer D (ed.): Baculovirus and Insect Cell Expression Protocols, 2nd edition, *Methods in Molecular Biology* 388: 77-93, Humana Press, Totowa, NJ.
11. **Sambrook J and Russell DW** (2000). Molecular Cloning, A Laboratory Manual, 3rd edition. Cold Spring Harbor Laboratory Press, Cold Spring Harbor, available online at <http://cshprotocols.cshlp.org>
12. **Sano K, Maeda K, Oki M, Maeda Y** (2002). Enhancement of protein expression in insect cells by a lobster tropomyosin cDNA leader sequence. *FEBS Letters* 532: 143-146
13. **Slack JM, Kuzio J and Faulkner P** (1995). Characterization of v-cath, a cathepsin L-like proteinase expressed by the baculovirus *Autographa californica* multiple nuclear polyhedrosis virus. *Journal of General Virology* 76: 1091-1098.
14. **Trowitzsch S et al.** (2010). New baculovirus expression tools for recombinant protein complex production. *Journal of Structural Biology* 172: 45-54, epub Feb 21, 2010, doi: 10.1016/j.jsb.2010.02.010
15. **Vijayachandran LS et al.** (2011). Robots, pipelines, polyproteins: Enabling multiprotein expression in prokaryotic and eukaryotic cells. *Journal of Structural Biology*
16. **Wu N et al.** (2010). Enhancing DNA electrotransformation efficiency in *Escherichia coli* DH10B electrocompetent cells. *Electronic Journal of Biotechnology* 13, doi: 10.2225/vol13-issue5-fulltext-11 (<http://ejb.ucv.cl/index.php/ejbiotechnology/article/view/v13n5-11>)

NOTES:

G. Purchaser Notification

Limited Use Label License : Geneva Biotech

The purchase of this product conveys to the buyer the non-transferable right to use the purchased amount of the product and components of the product in research conducted by the buyer (whether the buyer is an academic or for-profit entity).

The buyer cannot sell or otherwise transfer **(a)** this product **(b)** its components or **(c)** materials made using this product or its components to a third party or otherwise use this product or its components or materials made using this product or its components for Commercial Purposes. The buyer may transfer information or materials made through the use of this product to a scientific collaborator, provided that such transfer is not for any Commercial Purpose, and that such collaborator agrees in writing **(a)** not to transfer such materials to any third party, and **(b)** to use such transferred materials and/or information solely for research and not for Commercial Purposes.

Commercial Purposes means any activity by a party for consideration and may include, but is not limited to: **(1)** use of the product or its components in manufacturing; **(2)** inclusion of the product as part of another product; **(3)** use of the product or its components to provide a service, information, or data; **(4)** use of the product or its components for *ex vivo* or *in vivo* therapeutic, diagnostic, prophylactic or other unauthorized commercial purposes; **(5)** use in foods, drugs, devices or cosmetics of any kind, or for consumption by or use in connection with or administration or application to humans or animals; **(6)** resale of the product or its components, whether or not such product or its components are resold for use in research, or **(7)** any use other than research use.

For products that are subject to multiple limited use label licenses, the terms of the most restrictive limited use label license shall control. Geneva Biotech will not assert a claim against the buyer of infringement of patents owned or controlled by Geneva Biotech which cover this product based upon the manufacture, use or sale of a therapeutic, clinical diagnostic, vaccine or prophylactic product developed in research by the buyer in which this product or its components was employed, provided that neither this product nor any of its components was used in the manufacture of such product.

If the purchaser does not agree with the terms or limitations of this limited use agreement, the customer can return the product at their own costs but for a full refund (excluding shipping, tax and handling fees).

For information about purchasing a license to use this product or the technology embedded in it for any use other than for research use please contact Geneva Biotech at contact@geneva-biotech.com