

MultiBacMam™

Viral Vector System for Delivery of Large Gene Circuits into Mammalian Cells



User Manual

Version 4.3 (October 2019)

TABLE OF CONTENTS

A. MultiBacMam™ Kit Contents	- 2 -
MultiBacMam™ Kit Plus Competent Cells Contents	- 3 -
B. Introduction System Key Components.....	- 5 -
C. New Tools for Multigene Applications in Mammalian Cells	- 12 -
C.1. Transfer vectors: the Acceptor-Donor recombineering system.....	- 12 -
C.2. Generating multigene expression cassettes.....	- 15 -
C.2.1. Using the homing endonuclease/BstXI multiplication module	- 15 -
C.2.2. Multigene construction using Cre-Lox recombination	- 18 -
C.2.3. Combining HE/BstXI cycling and Cre-Lox recombination	- 19 -
D. Protocols.....	- 20 -
D.0 Introductory remarks	- 20 -
D.1 Cloning into pACEMam or pMDx transfer vectors	- 20 -
D.2 Multiplication by using the HE and BstXI sites	- 20 -
D.3.1. Protocol 1: Multiplication by using homing endonuclease/BstXI.	- 21 -
D.3.2. Protocol 2: Cre-LoxP fusion of Acceptors and Donors	- 23 -
D.3.3. Protocol 3: Deconstruction of fusion vectors by Cre	- 26 -
D.3.4. Protocol 4: Mammalian cell transfection protocol (HeLa cells):.....	- 26 -
D.3.4 Transposition protocol for pACEBac derivatives (electroporation or chemical) ..	- 26 -
D.3.5 Bacmid preparation and infection of insect cells	- 26 -
E. Appendix	- 32 -
E.1. Preparing bacterial stock from agar stabs	- 33 -
E.2. MultiBacMam™ vectors: maps, sequences, MCS, restriction	- 34 -
E.2.1 Acceptor vectors	- 35 -
E.2.1.1 pACEMam1: 3443 bp	- 35 -
E.2.1.2 pACEMam2: 4618 bp	- 38 -
E.2.2 Donor vectors.....	- 41 -
E.2.2.1 pMDC: 2889 bp	- 41 -
E.2.2.2 pMDK: 4130 bp	- 43 -
E.2.2.3 pMDS: 4088 bp.....	- 46 -
E.3 MultiBacMam™ genome.....	- 46 -
E.4 Compatibility of Mammalian Cells for BacMam-Mediated Transduction	- 46 -

F. References..... - 49 -
G. Purchaser Notification : Limited Use Label License - 57 -

NOTES

MultiBacMam™ Kit Plus Competent Cells Contents.

- **Plasmid acceptor vectors**

pACEMam1, pACEMam2; approx. 5 µg DNA per vial (in buffer solution)

keep at 4°C for short-term storage and in a freezer at -20°C or lower for medium- and long-term storage (take care to avoid repeated freeze-thaw cycles, e.g. by aliquotting DNA prior to freezing)

- **Plasmid donor vectors**

pMDC, pMDK, pMDS; approx. 5 µg DNA per vial (in buffer solution)

keep at 4°C for short-term storage and in a freezer at -20°C or lower for medium- and long-term storage (take care to avoid repeated freeze-thaw cycles, e.g. by aliquotting DNA prior to freezing)

- **E. coli strains as competent cells**

a) *E. coli* strain harboring DH10EMBacVSV™ bacmid (12 aliquots of 100µl chemical competent cells)

The DH10EMBacVSV backbone contains a constitutively expressing mCHERRY expression cassette which allows for easy monitoring of viral titres via fluorescence without plaque assays.

c) pirHC cells[†] (5 aliquots 100µl each chemical competent cells)

For propagation and amplification of donor vectors, donor multigene expression constructs or donor-donor fusions

Keep competent cells at -80°C **do not store at -20!**

[†] *E. coli* strains expressing the *pir* gene for propagation of donor vectors (any other strain with *pir*⁺ background can be used as well). HC: high copy number propagation of plasmids with R6Kγ origin.

Reagents to be supplied by the user (see also Section D. Protocols)

- Restriction enzymes and Homing endonucleases PI-SceI and I-CeuI
- Mammalian cells, e.g. HEK293, CHO, etc.
- T4 DNA ligase
- Cre recombinase
- Standard *E. coli* strains for cloning (such as TOP10, DH5 α , HB101 etc.)
- Standard laboratory buffers, solutions, media and equipment for bacterial and mammalian cell culture, transformation etc.
- Commercially available transfection reagents, e.g. FuGENE[®] (Roche), jetPEI[™] (Polyplus transfection), etc. or an apparatus for electroporation
- Antibiotics

B. MultiBacMam™ Expression System Key Components:

- MultiBacMam™ is a MultiBac™-based viral vector system which is VSV-pseudotyped to enhance mammalian cell transduction efficiency.
- Comprises the DH10EMBacVSV genome, and a series of plasmid transfer vectors that enable multiprotein expression in a broad range of mammalian and primary cells
- Hybrid promoter vectors are available which enable the same virus to express in both insect and mammalian cells
- MultiBacMam™ has **mCherry** in the DH10EMBacVSV backbone which is only active in insect cells, to enable easy visualization of successful virus production.
- **Genes of interest** are integrated via transfer plasmids into DH10EMBacVSV cells by Tn7 transposition/blue white screening according to standard protocols (e.g. Bieniossek et al, Current Protocols 2008).

General Introduction: cellular interaction networks and protein complexes

In 1998, Bruce Alberts confronted conventional thinking that predicated on the action of individual proteins on Beadle and Tatum's one-gene/one-enzyme hypothesis (published in 1941) which for decades had shaped much of biological research. Instead, Alberts asked us to direct our focus to a modular cellular machinery composed of protein complexes (Alberts, 1998).

Proteins are the physical representatives of the information encoded by their corresponding genes and mRNAs. They are themselves embedded into a tightly and intricately regulated DNA-RNA-network (Vidal et al., 2011). These proteins determine many structural and physiological properties of cells but rarely act in isolation to mediate their effects. More often than not they will have multiple partners - not only proteins but also nucleic acids and small molecules – which they bind or bind to or associate with in larger complexes. Whether you look at replication, transcription, translation, transport processes across internal and external membranes, signaling events, etc. - protein complexes come into play in all of these processes. More importantly, such complexes – if disrupted by mutations

or the like - also engender often severe physiological deficits (Ehmsen et al., 2002; Vidal et al., 2011). Some of these complexes will, by their functional nature, either be long-lived ("stable") or transitory. Fleeting interaction of proteins, e.g. in cell signaling, will result in only minute amounts of a protein complex that usually also exists for only a limited period of time.

Deconvoluting this social life of the cell (Robinson et al., 2007) is a daunting task but has been tackled with high resolution imaging and analysis techniques (cryoEM, X-ray crystallography, NMR, mass spectroscopy, etc.). Extensive bioinformatics work-up and computer modeling support the experimental structural biology work and contribute to solving complex multi-subunit assemblies down to the atomic level (e.g. Imasaki et al., 2011). All these results enter into a better understanding of molecular interactions between proteins and other macromolecules, now known as the **interactome** (Figeys, 2008; Charbonnier et al., 2008) and their effects on the biological system of the cell.

Multiprotein expression tools

Various heterologous systems have been developed for the major production/host organisms *E.coli*, yeast, insect and mammalian cells. While sophisticated systems for expressing individual proteins exist, the repertoire of tools for multiprotein expression to date is rather limited (e.g., Bieniossek et al. 2009; Trowitzsch et al., 2010), especially for mammalian cells.

This cell culture of transgene-expressing cells has become one of the mainstays of functional investigations in cellular physiology and biochemistry. Co-transfection, whether by biochemical or physical means or through viruses, still is the method of choice when it comes to delivering genes of interest into mammalian cells. Co-transfection often fails to warrant uniform and constant expression of all vectors in one transfection experiment. Stable transfection remedies this problem to a certain degree but is cumbersome and requires multiple rounds of selection and re-culturing to yield uniform and stable clones.

Vector systems that enable uniform transient and, also stable transfection of multiple genes are in demand for mammalian cells. This manual introduces a set of novel mammalian transfer vectors that specifically enables efficient delivery of large DNA circuits into a wide range of mammalian cells.

The role of protein interaction networks (the so-called **interactome**) has become an intense focus of biological research efforts in the post-genomic era. Many of the identified multiprotein complexes are expressed at only low abundance in their native cells. This makes analysis of their structure difficult, but this can be remedied by using recombinant technologies to facilitate large-scale heterologous protein production. Currently, recombinant expression methods require a disproportionate investment in both labor and materials prior to multiprotein expression, and, once expression has been established, provide little or no flexibility for rapidly altering the multiprotein components, which is a prerequisite for revising expression studies. The mammalian expression system introduced here boasts **three** major advances that are instrumental in fully exploiting the potential of this heterologous protein production system:

Advance 1: New transfer vectors (pACEMam1, pACEMam2, pMDC, pMDK, pMDS; see Figure 1) that contain a homing endonuclease-based multiplication module. These vectors greatly facilitate modular combination of heterologous genes (in their respective gene expression cassettes) with a minimum requirement for unique restriction sites (BstXI). Strong viral/mammalian promoters (currently CMV and the hybrid CAG promoters) can be exchanged in our vectors for other promoter sequences if desired. Likewise, terminator sequences (currently SV40, rabbit β -actin) can be substituted as required.

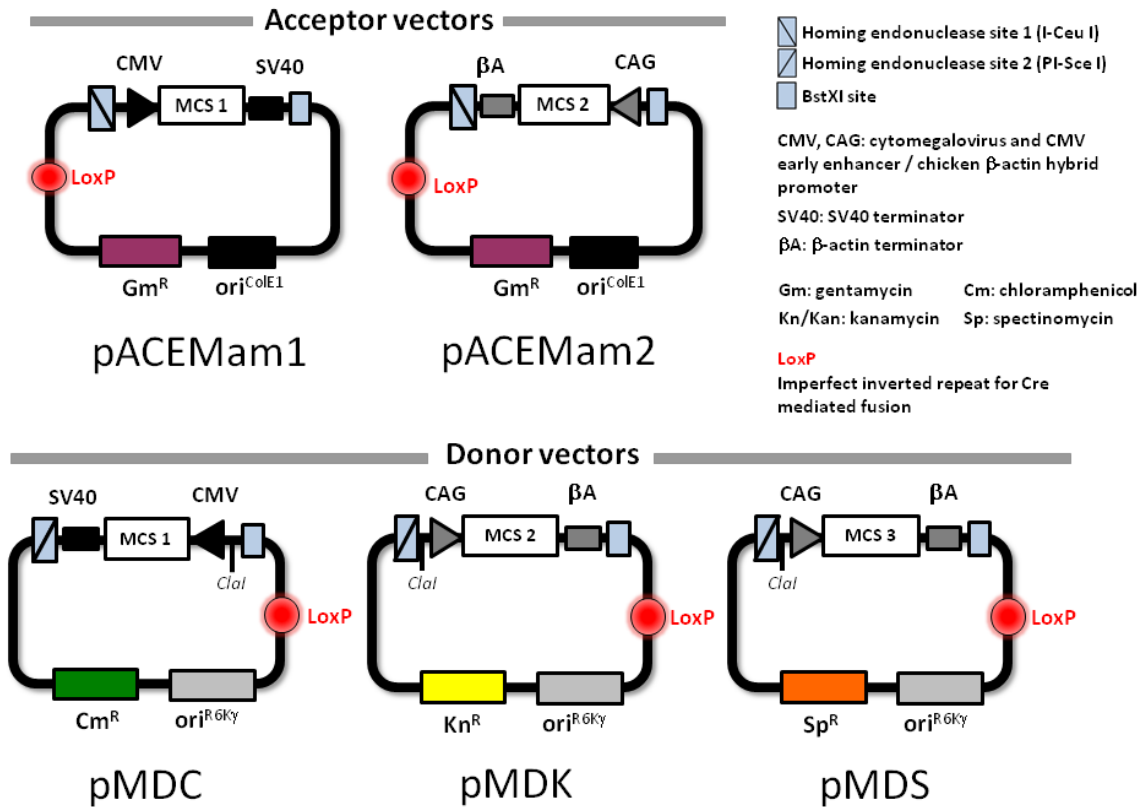

Figure 1: Schematic representation of the MultiBacMam™ acceptor and donor vectors. More detailed vectors maps and sequence information can be found in Chapter E.

Advance 2: New protocol for rapid generation of multigene expression constructs via Cre-LoxP recombineering. The resulting multigene fusion can then be transfected directly into mammalian cells for transient expression. This protocol can be used to integrate multigene cassettes with coding sequences for multiprotein complex subunits but also to integrate specific enzymes (kinases, acetylases etc.) for modifying the proteins under investigation.

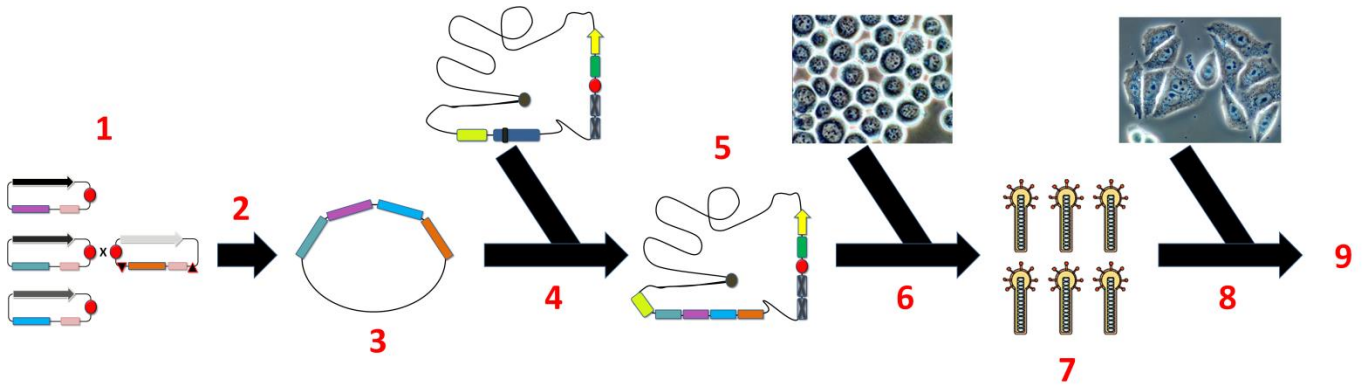

Figure 2a: Schematic overview of the MultiBacMam™ system and its application.

1) Design and clone your gene(s) of interest (GOIs) into MultiBacMam™ acceptor and donor vectors. 2) Match and mix your GOIs and then (re)combine them into one construct. 3) Select your construct using unique combination of antibiotic markers. 4) Transfer the entire GOIs-assembly into the DH10EMBacVSV™ bacmid. 5) Select and amplify your gene-containing DH10EMBacVSV™ bacmid. 6) Transfect insect cells with purified DH10EMBacVSV™ bacmid. 7) Amplify baculovirus in insect cells and collect desired scale of virus. 8) Transfect mammalian cells with baculovirus. 9) Drug discovery, bioproduction, stem cell differentiation etc.

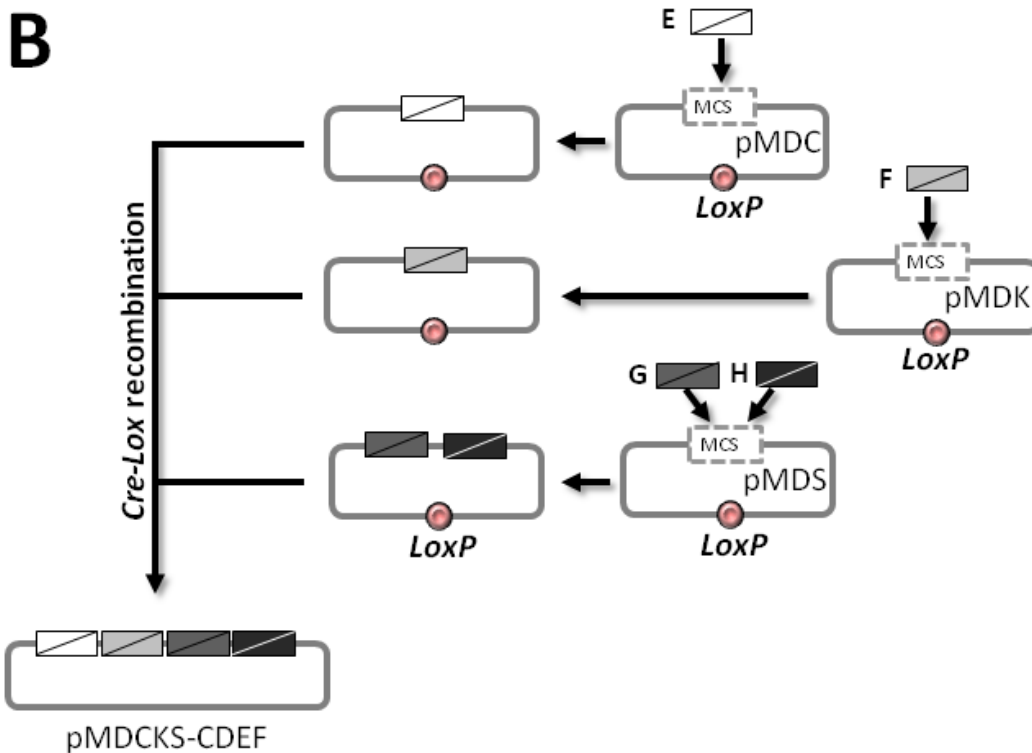

Figure 2B: Generation of multigene donor constructs through Cre-Lox fusion.

As indicated in Figure 2A, donor multigene expression cassette constructs can also be generated by Cre-Lox recombination. Individual or multiple gene cassettes are cloned into the multiple cloning site via standard restriction-ligation cloning or, when introducing multiple gene cassettes, homing endonuclease /BstXI cloning. The gene cassettes harbored on different donor vectors are then merged into a single vector construct via Cre-Lox recombination. This construct will differ from the multigene constructs in Figure 2a with respect to selective markers. While the multigene construct in fig. 2A carries only one antibiotic resistance marker, the construct in fig. 2B will carry three, one from each donor vector. This will allow selection of multigene constructs with higher

stringency by subjecting the constructs to a multi-antibiotic selection regimen (refer to protocol 2). *LoxP* sites in the donor fusion have been omitted for reasons of clarity.

Advance 3: MultiBacMam™ boasts the first "mammalianized" baculovirus genome: displaying a vesicular stomatitis virus (VSV) peptide on the baculovirus surface that increases virus uptake by an order of magnitude, and a stably integrated mCherry fluorescent protein expression cassette to simplify monitoring of virus amplification (Figure 2C). Prior art BacMam systems bring VSV pseudotyping together with your GOI, which generates significant selection pressure against the VSV DNA and results in lower protein density of the VSV relative to our system.

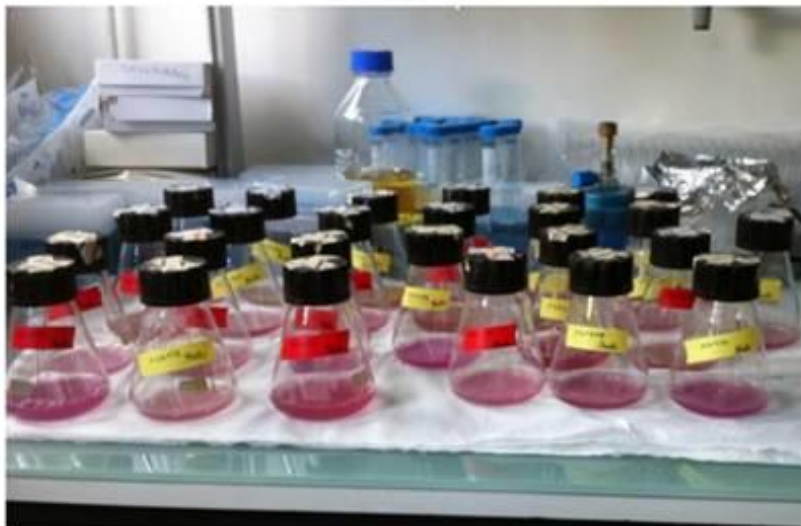

Figure 2C: Amplification of MultiBacMam™ virus in insect cell shaker cultures.

C. New Tools for Multigene Applications in Mammalian Cells

C.1. Transfer vectors: the Acceptor-Donor recombineering system.

The **Acceptor vectors** pACEMam1 and pACEMam2 contain multiple cloning sites (MCS; see appendix) flanked by either a CMV or CAG promoter to drive high-level expression in mammalian cells with appropriate polyA signal sequences when necessary (SV40 late for pACEMam1).

A multiplication module M – defined by the homing endonuclease site I-CeuI and a corresponding BstXI site (see Figure 3) – allows integration of multiple gene cassettes (ORFs and associated regulatory regions).

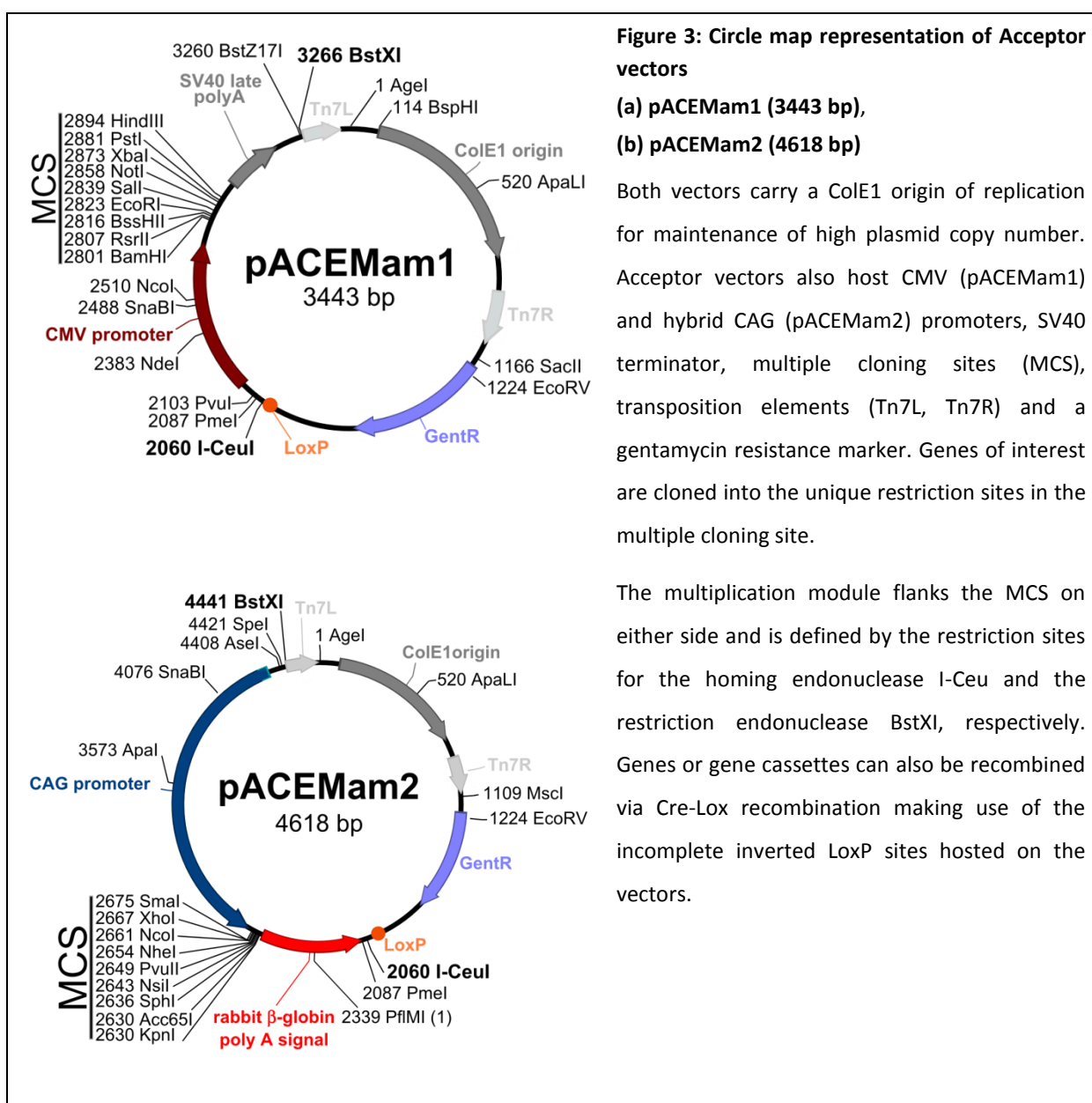

The **Donor vectors** pMDC, pMDS, pMDK are similar to the acceptor vectors with respect to their over-all design. The multiple cloning site is bracketed by a multiplication element (in this case, PI-SceI / BstXI) to enable concatenation of inserts between the different donor vectors. **Donor** vectors also contain a *LoxP* incomplete inverted repeat to create acceptor-donor or donor-donor fusions. The vectors contain “tell-tale” resistance markers (pMDC: chloramphenicol, pMDK: kanamycin, pMDS: spectinomycin) and, importantly, a conditional R6K γ origin of replication which makes propagation of the donor vectors dependent on the expression of the *pir* gene in the prokaryotic host (such as the *pir*⁺ cells contained in the kit).

Figure 4: Circle map representation of Donor vectors a) pMDC, b) pMDK, c) pMDS.

Circle maps show promoters (CMV, CAG), terminators (SV40, rabbit β -globin), multiple cloning sites (MCS), the incomplete inverted repeat for *cre-lox* site-specific recombination (*LoxP*) and resistance markers (chloramphenicol, kanamycin, and spectinomycin, respectively). Genes of interest are cloned into the MCS using unique restriction sites. The multiplication module consists of the homing endonuclease site PI-SceI and the restriction endonuclease site BstXI. All donor vectors host a conditional R6K γ origin of replication.

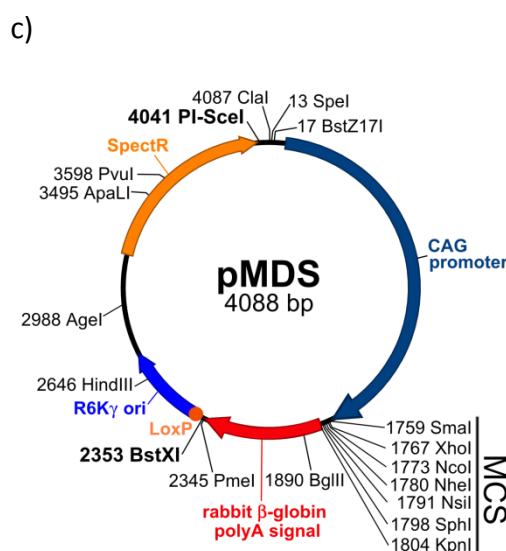
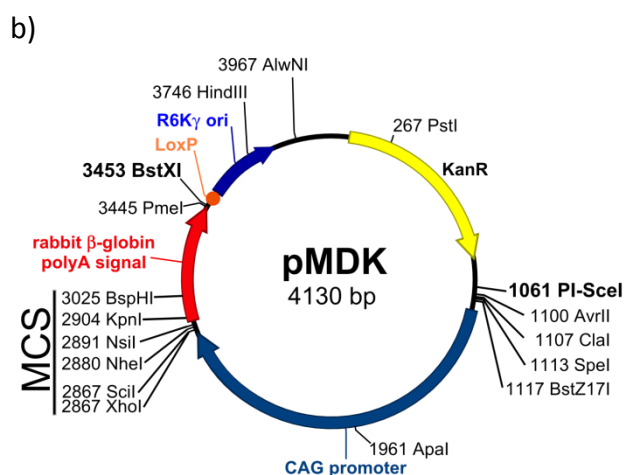
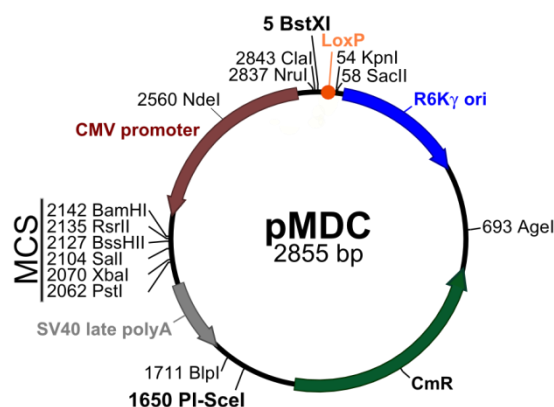

The MultiBacMam™ vectors in their current form do not contain DNA sequences that code for affinity tags (that will facilitate purification or solubilization of the protein(s) of interest). Tags that are typically used are C- or N-terminal oligohistidine tags, with or without protease cleavage sites for tag removal. They can be introduced by designing the respective PCR primers used for amplification of the genes of interest. We recommend outfitting Donors or Acceptors of choice with any custom tag that is favored in individual user laboratories prior to inserting recombinant genes of interest. This is best done by using a design that will, after tag insertion, still be compatible with the recombination-based principles of MultiBacMam™ system usage (Figs 5-8).

The same holds true for reporter genes, most notably fluorescent proteins that are commonly used in protein localization or protein interaction studies. These can also be fused to your protein under investigation using PCR techniques.

C.2. Generating multigene expression cassettes

C.2.1. Using the homing endonuclease/*Bst*XI multiplication module

The acceptor and donor vectors are suited for generating multigene expression cassettes from individual gene expression cassettes (complete with regulatory regions such as promoter and terminator) via a multiplication module bracketing the multiple cloning site (MCS). All MultiBacMam™ vectors contain a homing endonuclease (HE) site and a correspondingly designed *Bst*XI site that together bracket the MCS. Homing endonucleases have long recognition sites (20-30 base pairs or more). Although not all equally stringent, homing endonuclease sites are very likely unique in the context of even large plasmids, or, in fact, entire genomes.

The logic of multiplication is illustrated below. The homing endonuclease site can be used to insert entire expression cassettes into a vector that already contains one gene or several genes of interest as separate expression cassettes. The only prerequisite for assembling multigene expression cassettes is that the homing endonucleases and restriction enzymes used for multiplication (*I-CeuI*/*PI-SceI* and *Bst*XI) are unique, which can be easily accomplished, for instance by site-directed mutagenesis prior to multigene cassette assembly. First, individual genes are cloned into the multiple cloning sites of the acceptor and donor vectors. The entire expression cassette, including promoter and terminator, is then excised by *I-CeuI* / *Bst*XI (acceptors) or *PI-SceI* / *Bst*XI (donors) digestion. The resulting fragment is placed into the multiplication module of another acceptor or donor vector containing single or multiple gene cassettes. The restriction sites involved are eliminated in the process and multiplication can be repeated iteratively using the module present in the inserted cassette. Moreover, promoter and terminator sequences can be easily modified if desired using appropriate restriction sites in our vectors.

- ! Please note that multiplication cannot be accomplished from donors to vectors and vice versa since the overhangs generated by endonuclease digestion are incompatible.

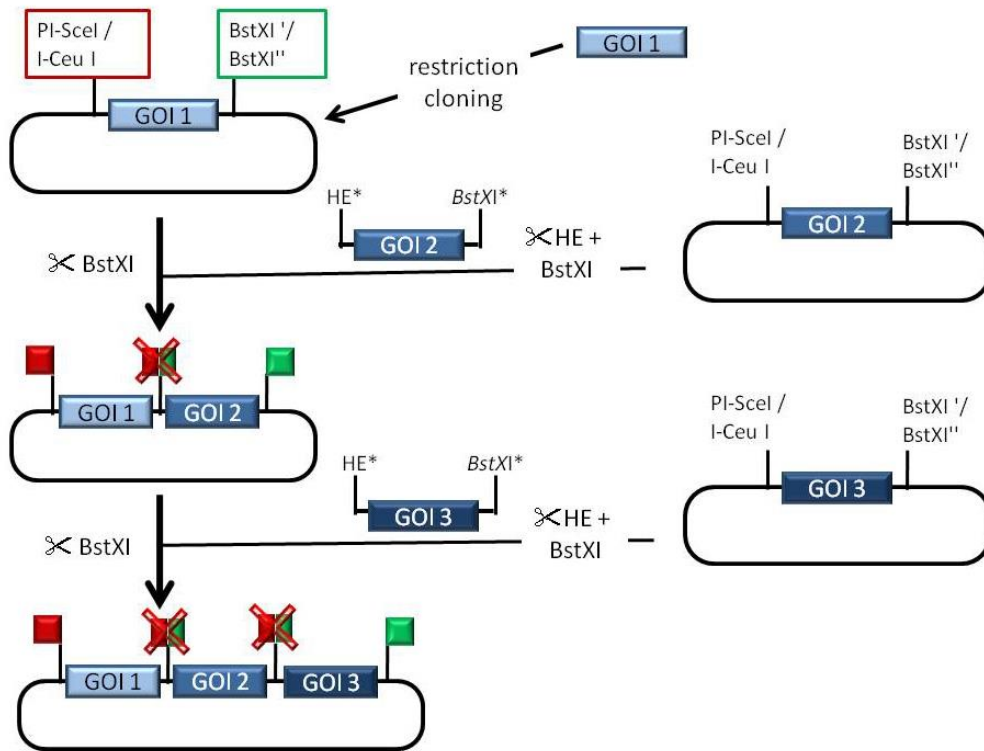
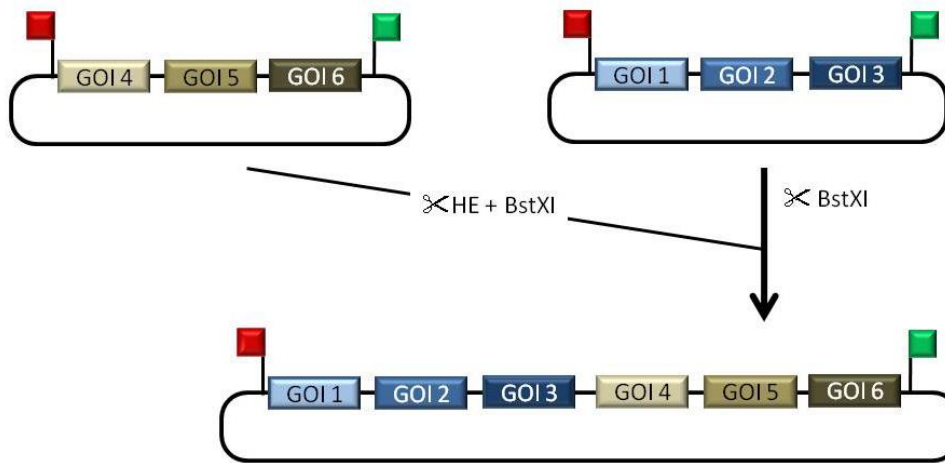

Figure 5: Assembling individual gene cassettes into multigene expression cassettes. The logic of multiplication is shown schematically. The expression cassette containing the gene of choice (denoted as GOI2 in this case) is excised by digestion with the homing endonuclease (red box) and BstXI (green box). For acceptor vectors, I-Ceu I is the homing endonuclease of choice, and for donor vectors PI-SceI. The plasmid vector harboring the GOI1-cassette only needs to be linearized with BstXI. The homing endonucleases produce cohesive ends that are compatible with the ends generated by the BstXI digest. Upon insertion of GOI2 into the target vector, a homing endonuclease/BstXI hybrid restriction site is created that can then cannot be cut by either enzyme (crossed-out red/green box) while the 3'-BstXI site is regenerated. The same procedure can be repeated over and over as exemplified by the integration of GOI3. This cycling logic can be used to generate multigene assemblies. Note that the promoters and terminators are not explicitly shown for reasons of clarity.

A



B

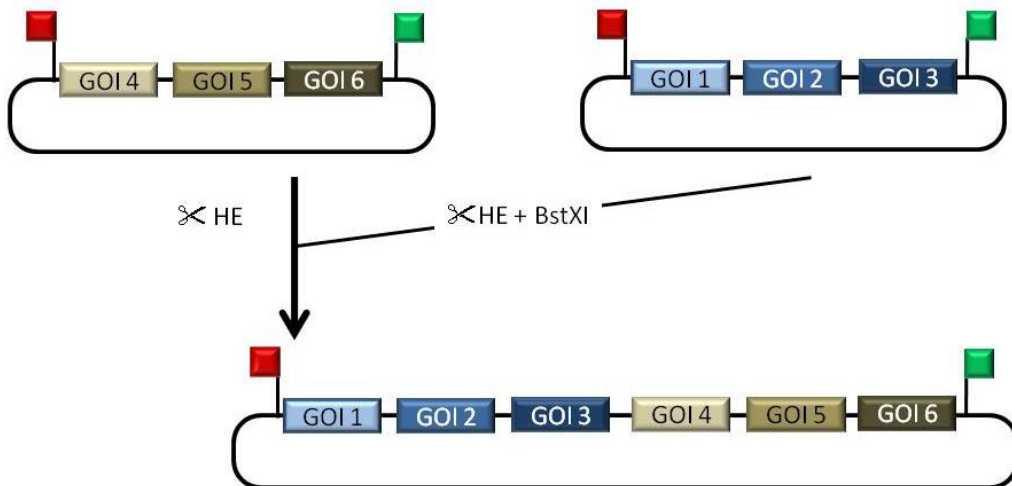

Figure 6: Combining multigene expression cassettes. Different multigene expression cassettes can be combined into one expression construct following the same logic that applies to the generation of multigene expression cassettes from individual gene cassettes (Figure 4). The 5' homing endonuclease recognition site (filled red box) will be preserved if GOI1 has been introduced by conventional restriction cloning into the MCS. Promoters and terminators are not explicitly shown for reasons of clarity but flank the GOIs in every individual gene expression cassette.

C.2.2. Multigene construction using Cre-Lox recombination

Cre recombinase is a member of the integrase family (Type I topoisomerase from bacteriophage P1). It recombines a 34 bp loxP site in the absence of accessory protein or any auxiliary DNA sequence. The loxP site is comprised of two 13 bp recombinase-binding elements arranged as inverted repeats which flank an 8 bp central region where cleavage and the ligation reaction occur.

The site-specific recombination mediated by Cre recombinase involves the formation of a Holliday junction (HJ). The recombination events catalyzed by Cre recombinase depend on the location and relative orientation of the loxP sites. Two DNA molecules, for example an acceptor and a donor plasmid, containing single loxP sites will be fused. Furthermore, the Cre recombination is an equilibrium reaction with 20-30% efficiency in recombination. This provides useful options for multigene combinations for multiprotein complex expression.

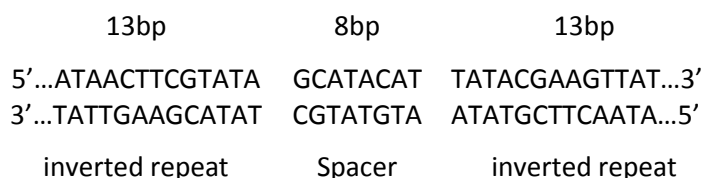

Figure 7: LoxP imperfect inverted repeat

In a reaction where several DNA molecules such as donors and acceptors are incubated with Cre recombinase, the fusion/excision activity of the enzyme will result in an equilibrium state where single vectors (educt vectors) and all possible fusions coexist. Donor vectors can be used with acceptors and/or donors, and vice versa. Higher order fusions are also generated where more than two vectors are fused. This is shown schematically in Figure 8.

The fact that Donors contain a conditional origin of replication that depends on a *pir*⁺ (*pir* positive) background now allows for selecting out from this reaction mix all desired Acceptor-Donor(s) combinations. For this, the reaction mix is used to transform *pir* negative strains (TOP10, DH5 α , HB101 or other common laboratory cloning strains). Then, Donor vectors will act as suicide vectors when plated out on agar containing the antibiotic corresponding to the Donor encoded resistance marker, unless fused with an Acceptor. By using agar with the appropriate combinations of antibiotics, all desired Acceptor-Donor fusions can be selected for.

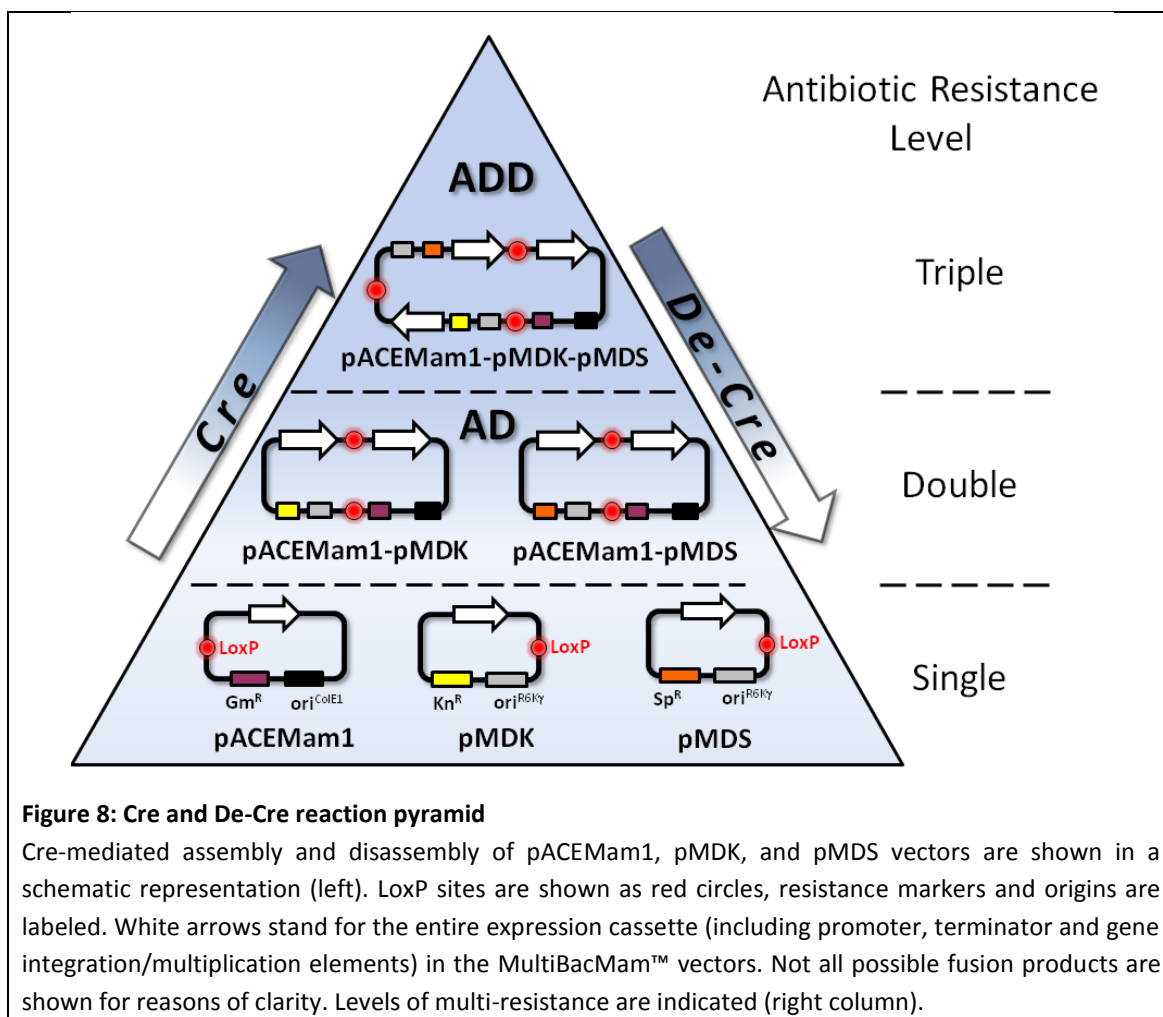

Figure 8: Cre and De-Cre reaction pyramid

Cre-mediated assembly and disassembly of pACEMam1, pMDK, and pMDS vectors are shown in a schematic representation (left). LoxP sites are shown as red circles, resistance markers and origins are labeled. White arrows stand for the entire expression cassette (including promoter, terminator and gene integration/multiplication elements) in the MultiBacMam™ vectors. Not all possible fusion products are shown for reasons of clarity. Levels of multi-resistance are indicated (right column).

C.2.3. Combining HE/BstXI cycling and Cre-Lox recombination

Of course, both methods can also be combined to generate multiple gene-expression cassette constructs. To this end, you can introduce multiple gene cassettes with the homing endonuclease/BstXI protocol into different Acceptor/Donor vectors and then fuse these using the Cre-Lox modules (illustrated in Figure 2a).

D. Protocols

D.0 Introductory remarks

Please note that the bacteria in the agar stabs have not been made competent for transformation. If you wish to use them to transform your constructs, you will have to prepare competent cells. This applies specifically to the pirHC and pirLC strains used to maintain donor constructs. You may follow your preferred protocol for preparing chemically or electrocompetent cells, e.g. Inoue et al. (1990) or variations of this protocol, or standard protocols as described in Current Protocols in Molecular Biology or Sambrook and Russell: Molecular Cloning (3rd edition, 2001, or older versions).

D.1 Cloning into pACEMam or pMDx transfer vectors

Reagents:

Restriction endonucleases

DNA ligase

E. coli competent cells

Antibiotics: Chloramphenicol, Gentamycin, Kanamycin, Spectinomycin

The genes of choice are cloned using standard cloning procedures into the multiple cloning sites MCS (see *Supplementary Information*) of pACEMam1/2 and pMDC, pMDK, pMDS. Ligation reactions for pACEMam derivatives are transformed into standard *E. coli* cells for cloning (such as TOP10, DH5 α , HB101) and plated on agar containing gentamycin (7 μ g/ml). Ligation reactions for pMDx derivatives are transformed into *E. coli* cells expressing the *pir* gene (pirHC from this kit – in this case you will need to make the cells electro- or chemically competent first; other strains, e.g. BW23473, BW23474) and plated on agar containing chloramphenicol (pMDC; 25 μ g/ml), kanamycin (pMDK; 50 μ g/ml) or spectinomycin (pMDS; 50 μ g/ml). Correct clones are selected based on specific restriction digestion patterns and DNA sequencing of the inserts.

D.2 Multiplication by using the HE and BstXI sites

MultiBacMam™ donor vectors contain a recognition site for the homing endonuclease PI-SceI (Figure 3). Upon cleavage, this HE site yields a 3' overhang with the sequence -GTGC. Acceptor vectors contain the homing endonuclease site I-CeuI (see Figure 2), which upon cleavage will result in a 3' overhang of -CTAA. On acceptors and donors, the respective HE site precedes the MCS (see Figure 2). The 3' end of

the MIE contains a specifically designed BstXI site, which upon cleavage will generate a matching overhang. The basis of this is the specificity of cleavage by BstXI. The recognition sequence of BstXI is defined as CCANNNNN'NTGG (the apostrophe marks the position of the phosphodiester link cleavage). The residues denoted as N can be chosen freely. Donor vectors thus contain a BstXI recognition site with the sequence CCATGTGC'CTGG, and Acceptor vectors contain CCATCTAA'TTGG. The overhangs generated by BstXI cleavage in each case will match the overhangs generated by HE cleavage. Note that Acceptors and Donors have different HE sites.

The recognition sites are not symmetric. Therefore, ligation of a HE/BstXI digested fragment into a HE site of an MultiBacMam™ vector will be (1) directional and (2) result in a hybrid DNA sequence where a HE half site is combined with a BstXI half site (see Figure 5). This site will be cut by neither the HE nor BstXI. Therefore, in a construct that has been digested with a HE, insertion by ligation of HE/BstXI digested DNA fragment containing an expression cassette with one or several genes will result in a construct which contains all heterologous genes of interest, enveloped by an intact HE site in front, and a BstXI site at the end. Therefore, the process of integrating entire expression cassettes by means of HE/BstXI digestion and ligation into a HE site can be repeated iteratively.

D.3.1 Protocol 1. Multiplication using homing endonuclease/BstXI.

Reagents required:

Homing endonucleases PI-SceI, I-CeuI
10x Buffers for homing endonucleases
Restriction enzyme BstXI (and 10x Buffer)
T4 DNA ligase (and 10x Buffer)
E. coli competent cells
Antibiotics

Step 1: Insert preparation

Restriction reactions are carried out in 40 µl reaction volumes, using homing endonucleases PI-SceI (Donors) or I-CeuI (Acceptors) as recommended by the supplier.

Acceptor or donor plasmid (≥ 0.5 µg) in ddH ₂ O	32 µl
10x restriction enzyme buffer	4 µl
10 mM BSA	2 µl

PI-SceI (Donors) or I-CeuI (acceptors)	2 µl
--	------

Reactions are then purified using a PCR extraction kit or by acidic ethanol precipitation, and subsequently digested with BstXI according to the supplier's recommendations.

HE digested DNA in ddH ₂ O	32 µl
10x restriction enzyme buffer	4 µl
10 mM BSA	2 µl
BstXI	2 µl

Gel extraction of insert(s):

Processed insert is then purified by agarose gel extraction using commercial kits (Qiagen, Macherey Nagel etc). Elution of the extracted DNA in the minimal volume defined by the manufacturer is recommended.

Step 2: Vector preparation

Restriction reactions are carried out in 40 µl reaction volumes, using homing endonucleases PI-SceI (Donors) or I-CeuI (Acceptors) as recommended by the supplier.

Acceptor or donor plasmid (≥ 0.5 µg) in ddH ₂ O	33 µl
10x Restriction enzyme buffer	4 µl
10 mM BSA	2 µl
PI-SceI (Donors) or I-CeuI (acceptors)	1 µl

Reactions are then purified by PCR extraction kit or acidic ethanol precipitation, and next treated with intestinal alkaline phosphatase according to the supplier's recommendations. Dephosphorylation is performed to minimize vector re-annealing and to increase integration of the insert.

HE digested DNA in ddH ₂ O	17 µl
10x Alkaline phosphatase buffer	2 µl
Alkaline phosphatase	1 µl

Gel extraction of vector:

Processed vector is then purified by agarose gel extraction using commercial kits (Qiagen, Macherey Nagel etc). Elution of the extracted DNA in the minimal volume defined by the manufacturer is recommended.

Step 3: Ligation

Ligation reactions are carried out in 20 µl reaction volumes:

HE/Phosphatase treated vector (gel extracted)	4 µl
HE/BstXI treated insert (gel extracted)	14 µl
10x T4 DNA Ligase buffer	2 µl
T4 DNA Ligase	0.5 µl

Ligation reactions are performed at 25°C for 1h or at 16°C overnight.

Step 4: Transformation

Mixtures are next transformed into competent cells following standard transformation procedures.

Ligation reactions for pACEMam1 and pACEMam2 derivatives are transformed into standard *E. coli* cells for cloning (such as TOP10, DH5 α , HB101) and, after recovery, are plated on agar containing gentamycin (7 $\mu\text{g/ml}$).

Reactions for Donor derivatives are transformed into *E. coli* cells expressing the *pir* gene (such as BW23473, BW23474, or PIR1 and PIR2 from Invitrogen and, of course, pirLC and pirHC in this kit) and plated on agar containing chloramphenicol (25 $\mu\text{g/ml}$, pMDC), kanamycin (50 $\mu\text{g/ml}$, pMDK), or spectinomycin (50 $\mu\text{g/ml}$, pMDS).

Step 5: Plasmid analysis

Plasmids are cultured and correct clones selected based on specific restriction digestion and DNA sequencing of the inserts.

D.3.2 Cre-LoxP reaction of Acceptors and Donors

Protocol 2: Cre-LoxP fusion of Acceptors and Donors

This protocol is designed for generating multigene fusions from Donors and Acceptors by Cre-LoxP reaction.

Reagents:

Cre recombinase (e.g. from NEB)

Standard *E. coli* competent cells (Top10 etc.)

Antibiotics

96-well microtiter plates

12 well tissue-culture plates (or Petri dishes) w. agar/antibiotics

LB or 2XYT bacterial medium

1. For a 20 μl Cre reaction, mix 1-2 μg of each educt in approximately equal amounts. Add ddH₂O to adjust the total volume to 16-17 μl , then add 2 μl 10x Cre buffer and 1-2 μl Cre recombinase (1-2 U) .
2. Incubate Cre reaction at 37°C (or 30°C) for 1 hour.
3. Optional: load 2-5 μl of Cre reaction on an analytical agarose gel for examination.
Heat inactivation at 70°C for 10 minutes before gel loading is strongly recommended.
4. For chemical transformation, mix 10-15 μl Cre reaction with 200 μl chemically competent cells. Incubate the mixture on ice for 15-30 minutes. Then perform heat shock at 42°C for 45-60 s.

Up to 20 µl Cre reaction (0.1 volumes of the chemically competent cell suspension) can be directly transformed into 200 µl chemical competent cells.

For electrotransformation, up to 2 µl Cre reaction can be directly mixed with 100 µl electrocompetent cells, and transformed by using an electroporator (e.g. BIORAD *E. coli* Pulser) at 1.8-2.0 kV.

Larger volumes of Cre reaction must be desalted by ethanol precipitation or via PCR purification columns before electrotransformation. The desalted Cre reaction mix should not exceed 0.1 volumes of the electrocompetent cell suspension.

The cell/DNA mixture can be immediately used for electrotransformation without prolonged incubation on ice.

5. Add up to 400 µl of LB (or SOC) medium per 100 µl of cell/DNA suspension immediately after the transformation (heat shock or electroporation).
6. Incubate the suspension in a 37°C shaking incubator overnight or for at least 4 hours (recovery period).

To recover multifusion plasmid containing more than 2 resistance markers, it is strongly recommended to incubate the suspension at 37°C overnight.

7. Plate out the recovered cell suspension on agar containing the desired combination of antibiotics. Incubate at 37°C overnight.
8. Clones from colonies present after overnight incubation can be verified by restriction digestion at this stage (refer to steps 12-16).

This quality control step should be carried out especially in the case that only one specific multifusion plasmid is desired.

For further selection by single antibiotic challenges on a 96 well microtiter plate, continue to step 9.

Several different multifusion plasmid combinations can be processed and selected in parallel on one 96 well microtiter plate.

9. For 96 well antibiotic tests, inoculate four colonies from each agar plate with different antibiotic combinations into approx. 500 µl LB medium without antibiotics. Incubate the cell cultures in a 37°C shaking incubator for 1-2 hours.
10. While incubating the colonies, fill a 96-well microtiter plate with 150 µl antibiotic-containing LB medium (following Illustration 7). It is recommended to add coloured dye (positional marker) in the wells indicated.

A typical arrangement of the solutions, which is used for parallel selections of multifusion plasmids, is shown in Figure 9. The concept behind the 96 well plate experiment is that every cell suspension from single colonies needs to be challenged by all four single antibiotics for unambiguous interpretation.

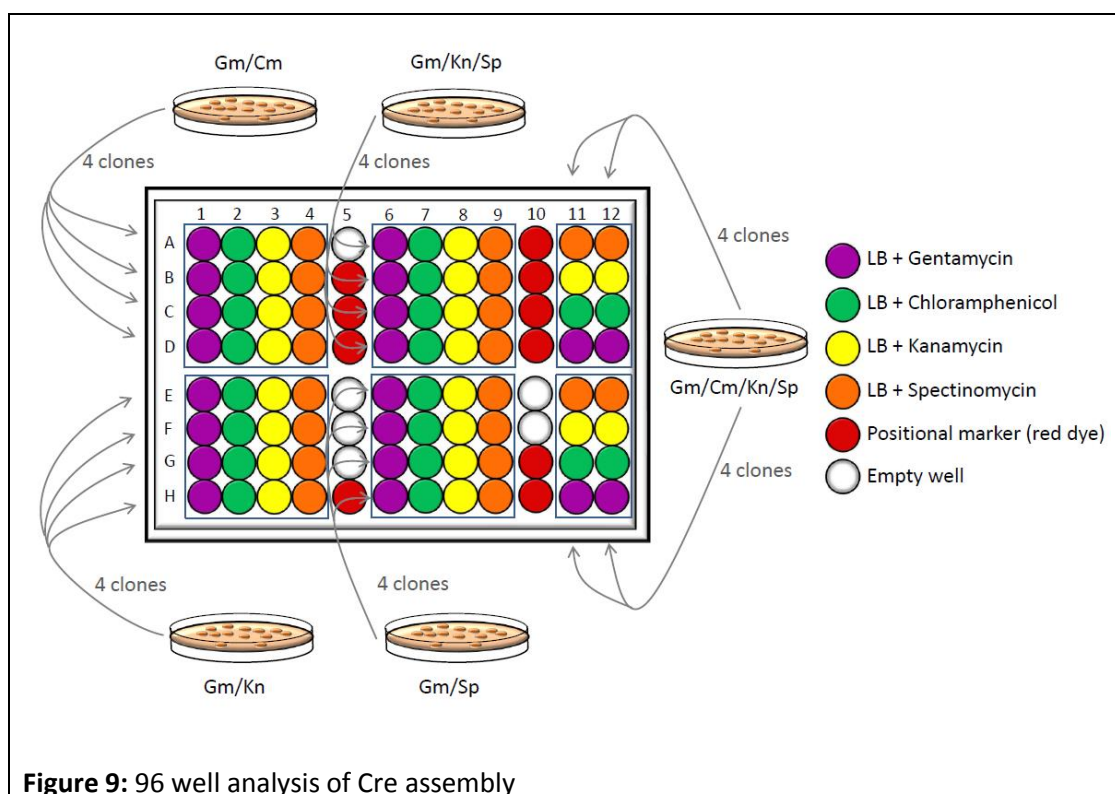

11. Add 1 μ l aliquots of pre-incubated cell culture (Step 9) to the corresponding wells. Then incubate the inoculated 96 well microtiter plate in a 37°C shaking incubator overnight at 180-200 rpm.

Recommended: use parafilm or any other adhesive seal to wrap the plate to avoid drying out. The remainder of the pre-incubated cell cultures can be kept at 4°C for further inoculations if necessary.

12. Select transformants containing desired multifusion plasmids based on antibiotic resistance, according to the combination of dense (positive) and clear (no growth) cell microcultures from each colony. Inoculate 10-20 μ l cell culture into 10 ml LB media with corresponding antibiotics. Incubate in a 37°C shaking incubator overnight.
13. Centrifuge the overnight cell cultures at 4000g for 5-10 minutes. Purify plasmid from the resulting cell pellets with common plasmid miniprep kits, according to manufacturer's recommendation.
14. Determine the concentrations of purified plasmid solutions by using UV absorption spectrophotometry (e.g. by using a NanoDrop™ 1000 machine).
15. Digest 0.5-1 μ g of the purified plasmid solution in a 20 μ l restriction digestion with appropriate endonuclease(s). Incubate under recommended reaction condition for approx. 2 hours.
16. Use 5-10 μ l of the digestion for analytical agarose (0.8-1.2%) gel electrophoresis. Verify plasmid integrity by comparing the experimental restriction pattern to a restriction pattern predicted *in silico* (e.g. by using program Snapgene, or VectorNTI from Invitrogen or similar programs).

D 3.3. Protocol 3. Deconstruction of fusion vectors by Cre

The following protocol is suitable for releasing any single educt from multifusion constructs (deconstruction). This is achieved by Cre-LoxP reaction; transformation and plating on agar with appropriately reduced antibiotic resistance level (cf. Figure 10). In the liberated educt entity, encoding genes can be modified and diversified. Then, the diversified construct is resupplied by Cre-LoxP reaction (C3.1).

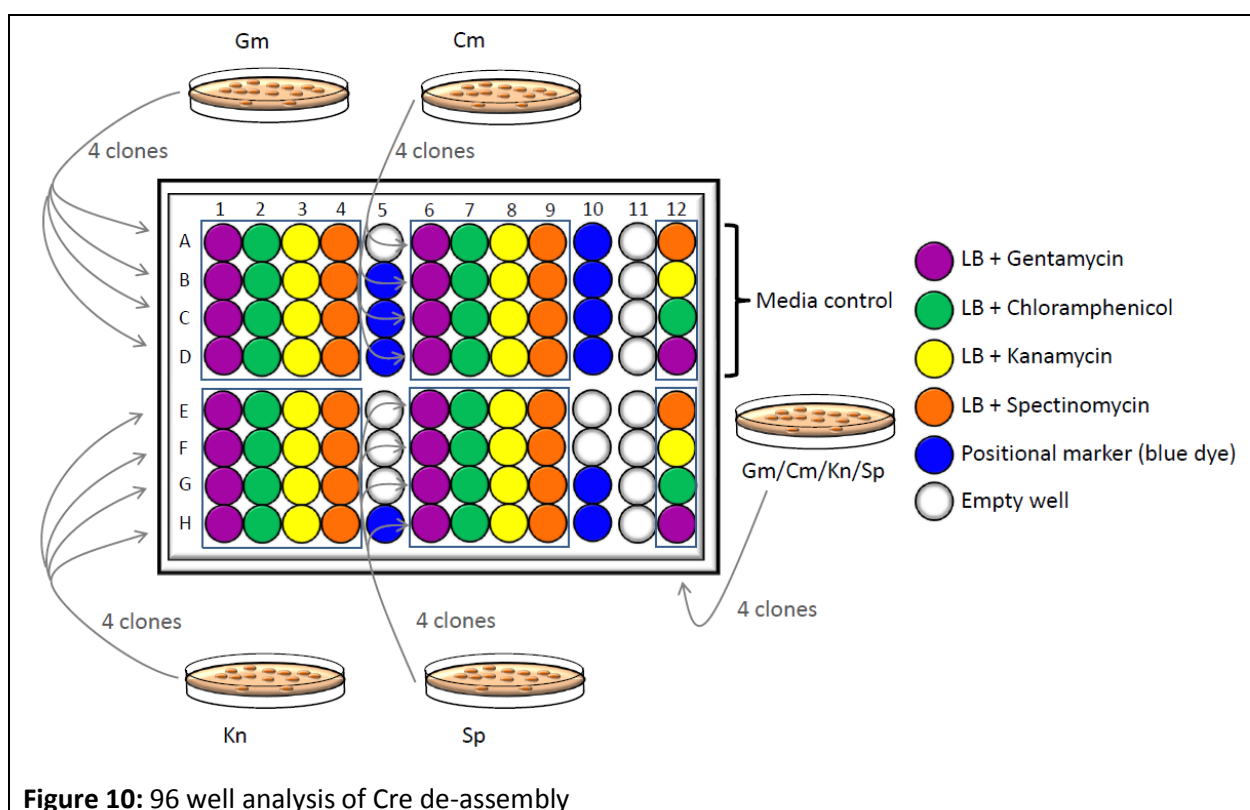

Reagents:

Cre recombinase (and 10x Buffer)

E. coli competent cells

(*pir*⁺ strains, *pir*⁻ strains can be used only when partially deconstructed Acceptor-Donor fusions are desired).

Antibiotics

1. Incubate approx. 1 µg multifusion plasmid with 2 µl 10x Cre buffer, 1-2 µl Cre recombinase, add ddH₂O to adjust the total reaction volume to 20 µl.
2. Incubate this Cre deconstruction reaction mixture at 30°C for 1 to 4 hour(s).
3. Optional: load 2-5 µl of the reaction on an analytical agarose gel for examination.

Heat inactivation at 70°C for 10 minutes before gel loading is strongly recommended.

4. For chemical transformation, mix 10-15µl De-Cre reaction with 200 µl chemically competent cells. Incubate the mixture on ice for 15-30 minutes. Then perform heat shock at 42°C for 45-60 s.

Up to 20 µl De-Cre reaction (0.1 volumes of the chemical competent cell suspension) can be directly transformed into 200 µl chemically competent cells.

For electrotransformation, up to 2 µl De-Cre reaction can be directly mixed with 100 µl electrocompetent cells, and transformed by using an electroporator (e.g. BIORAD *E. coli* Pulser) at 1.8-2.0 kV.

Larger volume of De-Cre reaction must be desalted by ethanol precipitation or PCR purification column prior to electrotransformation. The desalted De-Cre reaction mix should not exceed 0.1 volumes of the electrocompetent cell suspension.

The cell/DNA mixture can be immediately used for electrotransformation without prior incubation on ice.

5. Add up to 400 µl of LB media (or SOC media) per 100 µl of cell/DNA suspension immediately after the transformation (heat shock or electroporation).
6. Incubate the suspension in a 37°C shaking incubator (recovery).

For recovery of partially deconstructed double/triple fusions, incubate the suspension in a 37°C shaking incubator for 1 to 2 hours.

For recovery of individual educts, incubate the suspension in a 37°C shaking incubator overnight or for at least 4 hours.

7. Plate out the recovered cell suspension on agar containing the desired (combination of) antibiotic(s). Incubate at 37°C overnight.
8. Colonies after overnight incubation can be verified directly by restriction digestion at this stage (refer to steps 12-16).

This is especially recommended in cases where only a single educt or partially deconstructed multifusion plasmid is desired.

For further selection by single antibiotic challenge on a 96 well microtiter plate, continue with step 9.

Several different single educts/partially deconstructed multifusion plasmids can be processed and selected in parallel on one 96 well microtiter plate.

9. For 96 well analyses, inoculate four colonies each from agar plates containing a defined set of antibiotics into approx. 500 µl LB medium without antibiotics. Incubate the cell cultures in a 37°C shaking incubator for 1-2 hours.
10. While incubating the colonies, fill a 96 well microtiter plate with 150 µl antibiotic-containing LB medium or dye (positional marker) in the corresponding wells.
Refer to Figures 9 and 10 for the arrangement of the solutions in the wells, which are used for parallel selection of single educts or partially deconstructed multifusion plasmids. The concept is that every cell suspension from a single colony needs to be challenged by all four antibiotics separately for unambiguous interpretation.
11. Add 1 µl aliquots from the pre-incubated cell cultures (Step 9) into the corresponding wells. Incubate the 96 well microtiter plate in a 37°C shaking incubator overnight at 180-200 rpm.

Recommended: use parafilm to wrap the plate to prevent desiccation.

The remainder of the pre-incubated cell cultures can be kept at 4°C in a refrigerator for further inoculations if necessary.

12. Select transformants containing desired single educts or partially deconstructed multifusion plasmids according to the combination of dense (growth) and clear (no growth) cell cultures from each colony. Inoculate 10-20 μ l from the cell cultures into 10 ml LB media with corresponding antibiotic(s). Incubate in a 37°C shaking incubator overnight.
13. The next day, centrifuge the overnight cell cultures at 4000g for 5-10 minutes. Purify plasmid from cell pellets with common plasmid miniprep kits, according to manufacturers' protocols.
14. Determine the concentrations of purified plasmid solutions by using UV absorption spectroscopy (e.g. NanoDrop™ 1000).
15. Digest 0.5-1 μ g of the purified plasmid solution in a 20 μ l restriction digestion (with 5-10 units endonuclease). Incubate under recommended reaction condition for approx. 2 hours.
16. Use 5-10 μ l of the digestion for analytical agarose gel (0.8-1.2%) electrophoresis. Verify plasmid integrity by comparing the *de facto* restriction pattern to the *in silico* predicted restriction pattern (e.g. by using VectorNTI, Invitrogen, or any other similar program).
17. Optional: Occasionally, a deconstruction reaction is not complete but yields partially deconstructed fusions which still retain entities to be eliminated. In this case, we recommend to pick these partially deconstructed fusions containing and perform a second round of Cre deconstruction reaction (repeat steps 1-8) by using this construct as starting material.

D 3.4. Protocol 4. Mammalian cell transfection protocol (HeLa cells, monolayer, TC flask):

1. Plate HeLa cells on tissue culture flask (here T25cm²/T75cm²) following generic protocols.
2. Rinse HeLa cells twice with 10mL/15mL of 1xPBS (directly on the T25cm²/T75cm² flask, respectively), after taking off the supernatant from the cell culture plate.
3. Detach cells with 1mL/2mL Trypsin-EDTA 0.05% (T25cm²/T75cm² flask, respectively), by incubating for 1-3min at 37°C/5% CO₂ (hit culture plate 2-3 times if necessary to help cells detaching; avoid incubating times higher than 5min).
4. Add 10mL of DMEM complete media (containing 10% FCS and 8mM L-Glutamine) to stop trypsinization. Resuspend cells by pipetting up and down very gently.
5. Centrifuge down cells in a 50mL falcon at 1500-2000 rpm for 3min (using centrifuge available in the L2 room, model: Eppendorf 5702). Remove supernatant.
6. Resuspend cells in 6mL of DMEM complete media.
7. Count cells using a hemocytometer (neubauer chamber) and prepare a 15mL cell suspension at 2x10⁵ cells/mL.

8. Pipet/seed 500uL cells/well (24 wells plate) of the above prepared cell suspension (25uL/well or 1.5mL/well, if using 384 wells or 6 wells plates, respectively). Gently swirl the plate for homogeneous cell distribution.
Note: one should seed 5000 cells/well in 384 wells plates, 100'000 cells/well in 24 wells plates, 4×10^6 cells/well in 6 wells plates in order to have 80% cell confluency on the day itself (or next day).
9. Incubate at 37°C/5% CO₂ for 3-4h.
10. Test different MOI's of virus (0, 1, 10, 100, 500). MOI= multiplicity of infection; MOI=10 is equivalent to 10 infectious viral particles/cell.
11. Empty plate by aspirating the medium and add 300 µL of the transduction/transfection solution to each well of the 24 wells plate (50µL/well if using 384 wells plates and 1mL/well for 6 wells plates). Gently swirl the plate for homogeneous virus distribution.
Note: emptying plate by inversion can be used for 384 wells plates.
12. Centrifuge the plate at 1200 rpm for 30min at RT (centrifuge model: eppendorf 5804 R).
Note: due to the lack of an adequate centrifuge this step can only be done for 384 well plates
13. Incubate for 4h30 at 37°C/5% CO₂ (or 4h if centrifugation in step 11 was done).
14. Empty plate by aspirating the virus mix and add 500µL of complete DMEM media supplemented with 3mM sodium butyrate (25µL if using 384 wells plates and 1.5 mL in 6 wells plates). Sterilize the sodium butyrate previously by filtering it with a 0.22µm sterile filter.
Note 1: sodium butyrate enhances protein expression and transduction efficiency of the virus.
Note 2: emptying plate by inversion can be used for 384 wells plates.
15. Incubate overnight at 37°C/5% CO₂.
16. The following day check/scan/take picture of the cells on the L2 culture room microscope (live cells on 24 or 6 wells plates) / confocal microscope (fixed cells in cover slides or fixed/live cells in lab tek chambers). Take exposures at 24h, 48h and 72h.

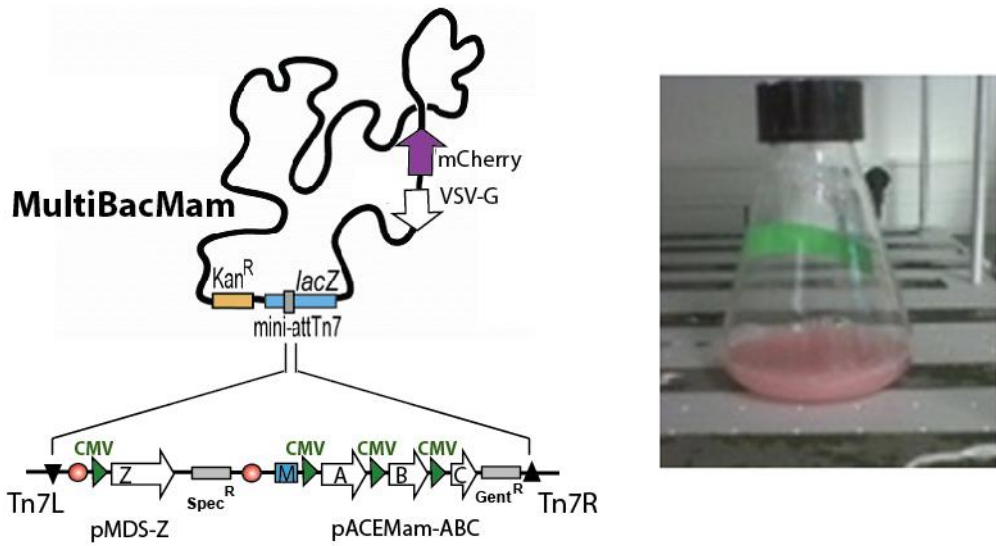

Figure 11: MultiBacMam™ virus amplified in insect cells (Sf21). Note that color of insect cells (mCherry production).

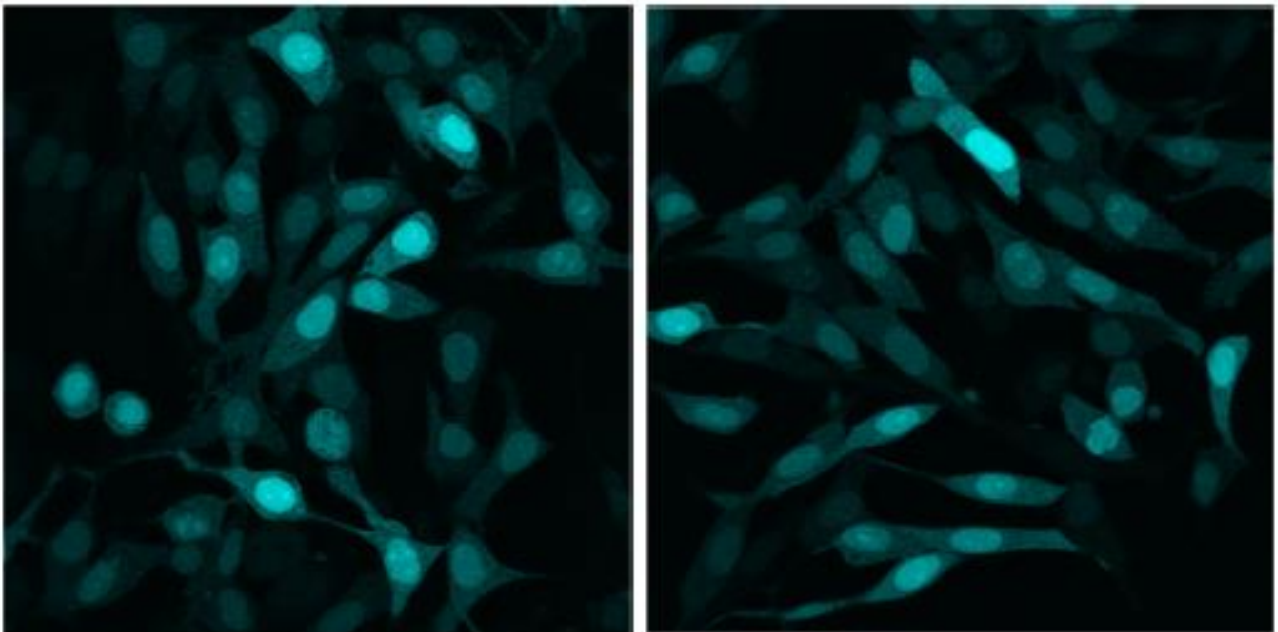

Figure 12: HeLa cells transfected with MultiBacMam™ virus expressing human transcription factor complex an CFP (under CMV control). Transfection is (close to) quantitative.

D.4. Transposition protocol for pACEMam derivatives (electrocompetent cells or chemical competent).

Reagents:

Electrocompetent or chemical competent DH10EMBacVSV cells

Kanamycin

Tetracyclin

Gentamycin

BluoGal

IPTG

Electroporation: Approximately 5-10 ng of the sequenced pACEMam derivative or of an acceptor-donor fusion is incubated on ice (15 min) with 50-100 µl electro-competent DH10EMBacVSV cells. Optimum electroporation settings need to be determined for the equipment used.

Transformation of chemical competent cells: Approximately 100 ng (maximally 10 µl volume) of the sequenced pACEMam derivative or of an acceptor-donor fusion is incubated on ice (30 min) with 50-100µl chemical-competent DH10EMBacVSV cells. Heat shock is carried out at 42 °C for 15 seconds and the cells are placed again quickly on ice.

Following electroporation or transformation using chemical competent cells, 500 microliters prewarmed SOC media is added to cells. Cells are incubated at 37 °C for 4 hours and plated on agar plates containing kanamycin (50 µg/ml), gentamycin (7 µg/ml), (ampicillin (100 µg/ml)), tetracyclin (10 µg/ml), BluoGal (100 µg/ml) and IPTG (40 µg/ml). X-gal at a concentration of (500 µg/ml) can substitute for BluoGal (100 µg/ml). We recommend plating a dilution series in SOC or 2XYT media, plating 300 microliters transformed cells on one plate, and plating 30 microliters transformed cells on a second plate.

White colonies are selected after incubation at 37 °C (24 hours). Deeper blue and white color colonies become more visible after leaving the plates for an additional day on the bench at room temperature. Proceed to bacmid preparation for insect cell infection (D.5.).

D.5. Bacmid preparation and infection of insect cells.

Preparation of bacmid DNA, infection of insect cells and protein expression is carried out according to established protocols, e.g. O'Reilly, D.R., Miller, L.K. & Luckow, V.A. "Baculovirus expression vectors. A laboratory manual." Oxford University Press, New York - Oxford, 1994 or David W. Murhammer (ed.). Baculovirus and Insect Cell Expression Protocols, 2nd edition, Methods in Molecular Biology™ 388, Humana Press, Totowa 2007. You may also refer to Fitzgerald et al. (2006), especially pp. 1025-27 and Bieniossek et al. (2008) for protocols on insect cell culture and bacmid preparation. These publications are available for download here [MultiBac Link](#).

Large plasmid kits (e.g. Qiagen) can also be used to extract recombinant bacmids, but we prefer precipitation of crude DNA with isopropanol from cleared lysate as described in Fitzgerald et al. (2006), especially pp. 1025-27 and Bieniossek et al. (2008) over using kits.

D.6. Determining MultiBacMam™ baculoviral production in insect cells

As you need to produce virus in insect cells prior to transduction of mammalian or primary cells, please refer to Fitzgerald et al. (2006), and Bieniossek et al. (2008) for protocols on insect cell culture virus production and bacmid preparation. These publications are available for download here [MultiBac Link](#).

Specific to the DH10EMBacVSV bacmid please see Figure 11. Note that color of insect cells infected with DH10EMBacVSV derivatives is a wine color due to mCherry production. To be clear, this mCherry is not produced subsequently in mammalian cells, because the production is driven by an insect cell specific baculovirus promoter that does not fire in mammalian cells.

E. Appendix

E.1. Preparing bacterial stock from competent cells

We recommend that you prepare your personal bacterial stock from the competent cells you received in the kit or transform your laboratory strain of choice with the vectors (please note that for the donor vectors this needs to be a pir+ strain). This is advisable since competent cells only have a limited shelf life.

To generate your bacterial stock for long-term storage, streak bacteria from the competent cells onto an appropriate selective plate (refer to the vector maps for acceptor and donor vectors) or plates without antibiotics (pirHC and pirLC strains; we recommend to test these strains against a panel of antibiotics to be on the safe side; no growth of colonies should be observed under conditions of antibiotic selection). Incubate the plates over night at 37°C and then proceed to prepare stocks from individual colonies for long-term storage according to your protocol of choice (glycerol, DMSO, etc.), as described, for example, in Inoue et al. (1990), *Molecular Cloning* (Sambrook and Russell, 2000), *Current Protocols in Molecular Biology* (Ausubel et al., 1994), etc.

E.2. MultiBacMam™ vectors: maps, sequences, MCS, restriction

Note: All acceptor and donor vector sequences can be provided in electronic format. These sequences contain all relevant information such as unique restriction sites, oris, resistance markers, etc. that is also shown in the circle maps. Request your set of vector files and accompanying files from Geneva Biotech at contact@geneva-biotech.com.

Acceptor and donor vectors are presented as circle maps and, in addition, the multiple cloning site (MCS) of each vector is shown featuring relevant unique restriction sites. Moreover, you will find, for the purposes of designing a restriction strategy, a non-exhaustive list of restriction endonucleases that cut once, twice or not at all. Additional restriction sites can be identified with any sequence analysis software, e.g. Snapgene, VectorNTI, ApE, etc. or by using online tools such as WebCutter 2.0 (<http://rna.lundberg.gu.se/cutter2>) or the NEB cutter V2.0 (<http://tools.neb.com/NEBcutter2/>).

E.2.1 Acceptor vectors

E.2.1.1 pACEMam1: 3443 bp

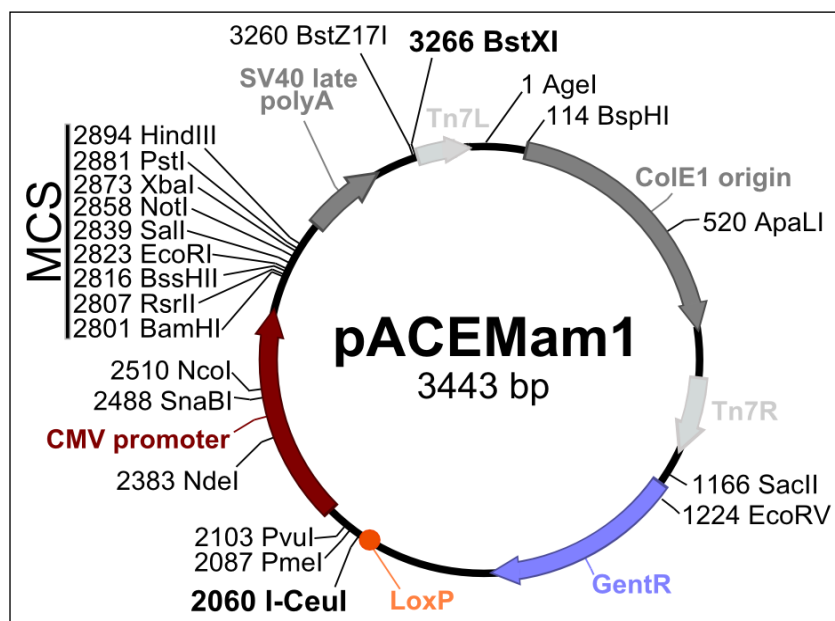

Multiple Cloning Site (promoter to terminator)

AatI
BamHI RsrII BssHII EcoRI StuI Sali
GGCTAGTGGATCCCGGTCCGAAGCGCGCGGAATTCAAAGGCCTACGTCGACGAGCTCACTTGT

NotI BstBI XbaI PstI HindIII
CGCGGCCGCTTTTCGAATCTAGAGCCTGCAGTCTCGACAAGCTTGTCGAGAAGTACTAGAGGA

Enzymes that cut pACEMam1 once (not exhaustive)

1	Age I	420	AlwNI	520	ApaLI	3254	AvrII
2801	BamHI , BstI	3231	BlpI	114	BspHI	2867	BstBI
2816	BssHII	3266	BstXI	3260	BstZ17I	2074	Bsu36I
2101	Clal	1979	DraIII	2823	EcoRI	1224	EcoRV
2894	HindIII	3020	HpaI	3009	MfeI	2128	MluI
1109	MscI	2510	NcoI	2383	NdeI	2859	NotI
2087	PmeI	2881	PstI	2103	PvuI	2807	RsrII
1166	SacII	2839	Sall	2907	Scal	2490	SnaBI
2833	StuI	2873	XbaI	1629			

Bold type: restriction enzymes cutting in the MCS

Enzymes that cut pACEMam1 twice (not exhaustive)

2839, 3260	AccI	2156, 2761	AseI / VspI	2714, 2845	BanII / SacI
949, 1418	BglII	1169, 2859	EagI	834, 1647	PciI
2095, 2149	SpeI				

Enzymes that do not cut pACEMam1 (not exhaustive)

Acc65I	AflII	Apal	Ascl	BbsI	BsaBI
Drall	EcoNI	FseI	KasI	KpnI	NaeI
NarI	NheI	NruI	NsiI	PacI	PfoI
PvuII	SbfI	SfiI	SfoI	Smal/XmaI	SphI
SrfI	SspI	XcmI	XhoI	XmnI	

Sequence

5' –

accggttgacttgggtcaactgtcagaccaagttaaactcatatataactttagattgatttaaaact
tcatttttaatttaaaaggatctaggtgaagatccttttgataatctcatgacaaaatccctta
acgtgagtttctggtccactgagcgtcagaccccgtagaaaagatcaaaggatcttcttgagatcc
ttttttctgcgcgtaactctgctgcttgcaaacaaaaaaccaccgctaccagcggtggtttggtt
gccggatcaagagctaccaactcttttccgaaggtaactggcttcagcagagcgcagataccaaa
tactgttctctagtgtagccgtagttagggcaccacttcaagaactctgtagcaccgcctacata
cctcgctctgctaactcctgttaccagtggtgctgctgccagtggcgataagtcgtgcttaccgggtt
ggactcaagacgatagttaccggataaggcgcagcggctcgggctgaacgggggggttcgtgcacaca
gccagcttggagcgaacgacctacaccgaactgagatacctacagcgtgagctatgagaaagcgc
cacgcttcccgaaggagaaaggcggacaggtatccggtaagcggcagggctcggaacaggagagcgc
cacgagggagcttccagggggaaacgcctggtatctttatagtcctgtcgggtttcgccacctctg
acttgagcgtcgatTTTTGTGATGCTCGTCAGGGGGCGGAGCCTATGGAAAAACGCCAGCAACGC
GGCTTTTTACGGTTCCTGGCTTTTGTCTGGCTTTTGTCTCACATGTTCTTCTCGCTTATCCCC
TGATTGACTTGGGTCTCTCTCTGTGGATGCGCAGATGCCCTGCGTAAGCGGGTGTGGGCGGACA
ATAAAGTCTTAACTGAACAAAATAGATCTAACTATGACAATAAAGTCTTAACTAGACAGAATA
GTTGTAACCTGAAATCAGTCCAGTTATGCTGTGAAAAAGCATACTGGACTTTTGTATGGCTAAAG
CAAACCTTTCATTTCTGAAGTGCAAATTGCCGTCGTATTAAGAGGGGCGTGGCCAAGGGCATG
TAAAGACTATATTCGCGGGCGTGTGACAATTTACCGAACAACTCCGCGGCCGGGAAGCCGATCTCG
GCTTGAACGAATTGTTAGGTGGCGGTACTTGGTCTGATATCAAAGTGCATCACTTCTTCCGATG
CCCACTTGTATAGAGAGCCACTGCGGGATCGTCACCCTAATCTGCTTGACGTAGATCACATAA
GCACCAAGCGCGTGGCCTCATGCTTGAGGAGATTGATGAGCGCGGTGGCAATGCCCTGCCTCCGG
TGCTCGCCGGAGACTGCGAGATCATAGATATAGATCTCACTACGCGGTGCTCAAACCTGGGCAGA
ACGTAAGCCGCGAGAGCGCAACAACCGCTTCTTGGTCTGAAGGCAGCAAGCGCGATGAATGTCTTA
CTACGGAGCAAGTTCCTCGAGGTAATCGGAGTCCGGCTGATGTTGGGAGTAGGTGGCTACGTCTCCG
AACTCACGACCGAAAAGATCAAGAGCAGCCCGCATGGATTTGACTTGGTCAGGGCCGAGCCTACAT
GTGCGAATGATGCCATACTTGAGCCACCTAATTTGTTTTAGGGCGACTGCCCTGCTGCGTAACA
TCGTTGCTGCTGCGTAACATCGTTGCTGCTCCATAACATCAAACATCGACCCACGGCGTAACGCGC
TTGCTGCTTGGATGCCCGAGGCATAGACTGTACAAAAAACAGTCATAACAAGCCATGAAAACGCGC
CACTGCGCGTACCACCGCTGCGTTCCGGTCAAGGTTCTGGACCAGTTGCGTGAGCGCATACGCTA
CTTGCAATTACAGTTTACGAACCGAACAGGCTTATGTCAACTGGGTTCCGTGCCTTCATCCGTTTCCA
CGGTGTGCGTCACCCGGCAACCTTGGGCAGCAGCGAAGTCGCCATAACTTCGTATAGCATAACATA
TACGAAGTTATCTGTAACATAACGGTCTAAGGTAGCGAGTTTAAACACTAGTATCGATCGCGAT
GTACGGGCCAGATATACCGGTTGACATTGATTATTGACTAGTTATTAATAGTAATCAATTACGGGG
TCATTAGTTCATAGCCATATATGGAGTTCGCGTTACATAACTTACGGTAAATGGCCCGCCTGGC
TGACCGCCAACGACCCCCGCCATTGACGTCAATAATGACGTATGTTCCCATAGTAACGCCAATA
GGGACTTTCATTGACGTCAATGGGTGGACTATTTACGGTAAACTGCCACTTGGCAGTACATCAA
GTGTATCATATGCCAAGTACGCCCCCTATTGACGTCAATGACGGTAAATGGCCCGCCTGGCATTAT
GCCAGTACATGACCTTATGGGACTTTCCTACTTGGCAGTACATCTACGTATTAGTCACTGCTATT
ACCATGGTGTATGCGGTTTTGGCAGTACATCAATGGGCGTGGATAGCGGTTTGACTCACGGGGATTT
CCAAGTCTCCACCCATTGACGTCAATGGGAGTTTGTTTTTGGCACAAAATCAACGGGACTTTC
AAATGTGTAACAACCTCCGCCCATTTGACGCAAAATGGGCGGTAGGCGTGTACGGTGGGAGGTCTAT
ATAAGCAGAGCTCTCTGGCTAACTAGAGAACCCTGCTTACTGGCTTATCGAAATTAATACGACT
CACTATAGGGAGACCCAAGCTGGCTAGTGGATCCCGGTCCGAAGCGCGCGGAATTCAAAGGCCTAC

gtcgacgagctcacttgtcgcgccgctttcgaatctagagcctgcagtctcgacaagcttgtcga
gaagtactagaggatcataatcagccataccacattttagtagaggttttacttgctttaaaaaacct
cccacacctccccctgaacctgaaacataaaatgaatgcaattggttggttaacttgtttattgc
agcttataatgggttacaataaagcaatagcatcaciaatttcaciaataaagcatttttttact
gcattctagttgtggtttgtccaaactcatcaatgtatcttatcatgtctggatctgatcactgct
tgagcctagaagatccggctgctaaciaagcccgaaaggaagctgagttggctgctgccaccgctg
agcaataactatcataaccctaggggtatacccatctaattggaaccagataagtgaaatctagtt
ccaaactattttgcatttttaattttcggtattagcttacgacgctacaccagttcccatctatt
ttgtcactcttcctaaataatccttaaaaactccatttccaccctcccagttcccaactatttt
gtccgccaca -3'

E.2.1.2 pACEMam2: 4618 bp

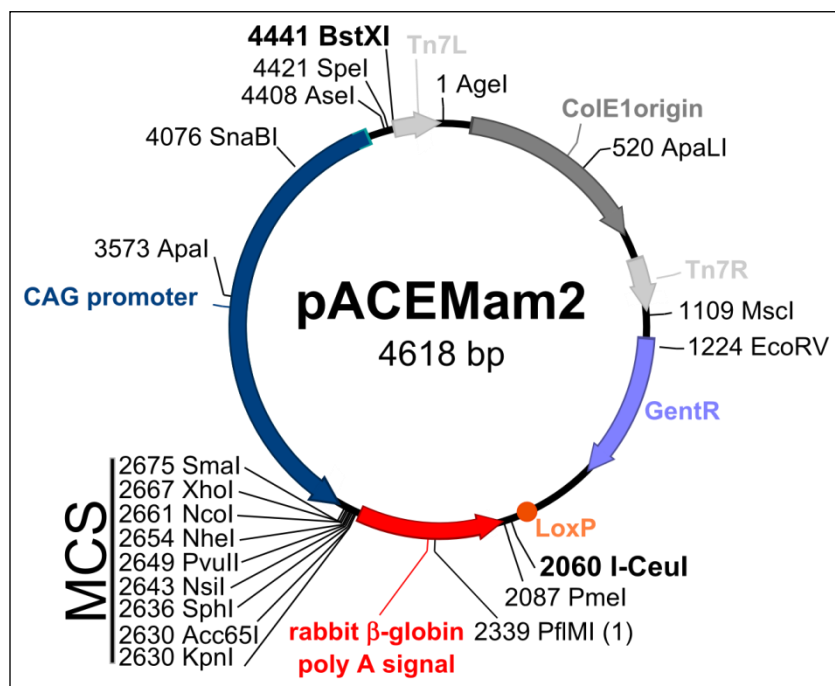

Multiple Cloning Site (promoter to terminator)

SmaI
 BbsI XmaI XhoI NcoI NheI PvuII
 GCGGCCGTCTCAGGCCACCGAAGACTTGATCA**CCCGGGATCTCGAGCCATGGTGCTAGCAGCT**

KpnI
 NsiI SphI Acc65I
GATGCATAGCATGCGGTACCTAA

Enzymes that cut pACEMam2 once (not exhaustive)

2630	Acc65I	1	Age I	420	AlwNI	3573	ApaI
520	ApaLI	4408	AseI, VspI	2688	BbsI	3278	BlpI
4441	BstXI	4417	BstZ17I	1224	EcoRV	888	FspI
2630	KpnI	1109	MscI	2661	NcoI	2654	NheI
2643	NsiI	2339	PflMI	2087	PmeI	2649	PvuII
2675	SmaI, XmaI	4076	SnaBI	4421	SpeI	2636	SphI
3120	Sse232I	2667	XhoI, ScI				

Bold type: restriction enzymes cutting in the MCS

Enzymes that cut pACEMam2 twice (not exhaustive)

3478, 3640	AfeI	114, 2509	BspHI	2967, 3010	BbeI, KasI, NarI, SfoI
2964, 3121	NaeI	1166, 3405	SacII		

Enzymes that do not cut pACEMam2 (not exhaustive)

AfIII	AscI	AvrII	BamHI	BclI	BsaBI
BspEI	BstBI	Clal	EcoNI	EcoRI	FseI
HindIII	HpaI	MfeI	MluI	NotI	NruI

Pacl	PstI	PvuI	RsrII	SacI	Sall
Sbfl	Scal	SfiI	SgfI	SrfI	Sspl
StuI	XbaI	XcmI	XmnI		

Sequence

5' -

accggttgacttgggtcaactgtcagaccaagtttactcatatataactttagattgattttaaact
tcatttttaatttaaaggatctaggtgaagatcctttttgataatctcatgaccaaactccctta
acgtgagttttcgttccactgagcgtcagaccccgtagaaaagatcaaaggatcttcttgagatcc
ttttttctgcgcgtaatctgctgcttgcaaacaaaaaaccaccgctaccagcgggtggtttgttt
gccggatcaagagctaccaactctttttccgaaggtaactggcttcagcagagcgcagatacctaaa
tactgttcttctagtgtagccgtagttaggccaccacttcaagaactctgtagcaccgctacata
cctcgtctgctaatcctgttaccagtggtgctgctgccagtggtgataagtcgtgtcttaccgggtt
ggactcaagacgatagttaccggataaggcgcagcggctcgggctgaacgggggggttcgtgacaca
gcccagcttggagcgaacgacctacaccgaaactgagatacctacagcgtgagctatgagaaagcgc
cacgcttcccgaaggagaaaaggcggacaggtatccggtaagcggcagggctcggaacaggagagcgc
cacgagggagcttccagggggaaacgcctggtatctttatagtcctgtcgggtttcggcacctctg
acttgagcgtcgatTTTTGTGATGCTCGTCAGGGGGCGGAGCCTATGGAAAACGCCAGCAACGC
GGCCTTTTACGGTTCCTGGCCTTTGCTGGCCTTTGCTCACATGTTCTTCTCGCTTATCCCC
TGATTGACTTGGGTCGCTCTTCTGTGGATGCGCAGATGCCCTGCGTAAGCGGGTGTGGGCGGACA
ATAAGTCTTAACTGAACAAAATAGATCTAACTATGACAATAAAGTCTTAACTAGACAGAATA
GTTGTAACACTGAAATCAGTCCAGTTATGCTGTGAAAAAGCATACTGGACTTTTGTTATGGCTAAAG
CAAACCTTTCATTTCTGAAGTGCAAATTGCCGTCGTATTAAGAGGGGCGTGGCCAAGGGCATG
TAAAGACTATATTCGCGGCGTGTGACAATTTACCGAACAACTCCGCGGCCGGGAAGCCGATCTCG
GCTTGAACGAATTGTTAGGTGGCGGTACTTGGGTCGATATCAAAGTGCATCACTTCTTCCCGTATG
CCCAACTTGTATAGAGAGCCACTGCGGGATCGTCACCGTAATCTGCTTGCACGTAGATCACATAA
GCACCAAGCGCGTGGCCTCATGCTTGAGGAGATTGATGAGCGCGGTGGCAATGCCCTGCCTCCGG
TGCTCGCCGGAGACTGCGAGATCATAGATATAGATCTCACTACGCGGCTGCTCAAACCTGGGCAGA
ACGTAAGCCGCGAGAGCGCCAACAACCGCTTCTTGGTCGAAGGCAGCAAGCGCGATGAATGTCTTA
CTACGGAGCAAGTCCCAGGTAATCGGAGTCCGGCTGATGTTGGGAGTAGGTGGCTACGTCTCCG
AACTCACGACCGAAAAGATCAAGAGCAGCCCGCATGGATTGACTTGGTCAGGGCCGAGCCTACAT
GTGCGAATGATGCCATACTTGAGCCACCTAACTTGTTTTAGGGCGACTGCCCTGCTGCGTAACA
TCGTTGCTGCTGCGTAACATCGTTGCTGCTCCATAACATCAAACATCGACCCACGGCGTAACGCGC
TTGCTGCTTGGATGCCGAGGCATAGACTGTACAAAAAACAGTCATAACAAGCCATGAAAACCGC
CACTGCGCCGTTACCACCGCTGCGTTCCGTCAGGTTCTGGACCAGTTGCGTGAGCGCATAACGCTA
CTTGCAATTACAGTTTACGAACCGAACAGGCTTATGTCAACTGGGTTCTGTCCTTCATCCGTTTCCA
CGGTGTGCGTCACCCGGCAACCTTGGGCAGCAGCGAAGTCGCCATAACTTCGTATAGCATAACATTA
TACGAAGTTATCTGTAACATAACGGTCCCTAAGGTAGCGAGTTTAAACGTCGAGGGATCTTCATAA
GAGAAGAGGGACAGCTATGACTGGGAGTAGTCAGGAGAGGAGGAAAAATCTGGCTAGTAAACATG
TAAGGAAAATTTTAGGGATGTTAAAGAAAAAATAACACAAAACAAAATATAAAAAAATCTAACC
TCAAGTCAAGGCTTTTCTATGGAATAAGGAATGGACAGCAGGGGGCTGTTTCATATACTGATGACC
TCTTATAGCCACCTTTGTTTATGTCAGCCAGCATATGGCATATGTTGCCAACTCTAAACCAAT
ACTCATTCTGATGTTTTAAATGATTTGCCCTCCCATATGTCTTCCGAGTGAGAGACACAAAAAT
TCCAACACACTATTGCAATGAAAATAAATTTCTTTATTAGCCAGAAGTCAGATGCTCAAGGGGCT
TCATGATGTCCCATAATTTTGGCAGAGGGAAAAAGATCTCAGTGGTATTTGTGAGCCAGGGCAT
TAGCCACACCAGCCACCACCTTCTGATAGGCAGCCTGCACCTGAGGAGTGAATTAGGTACCGCATG
CTATGCATCAGCTGCTAGCACCATGGCTCGAGATCCCGGGTGCATCAAGTCTTCCGGTGGCCTGAGAC
GGCCGCAATCTTTGCCAAAATGATGAGACAGCACAAACACCAGCACGTTGCCAGGAGCTGTAGG
AAAAAGAAGAAGGCATGAACATGGTTAGCAGAGGCTCTAGCAGCCGCGGTACACGCCAGAAGCC
GAACCCCGCCCTGCCCGTCCCCCGAAGGCAGCCGCTCCCCCTGCGGCAGCCCCGAGGCTGGAGA
TGGAGAAGGGGACGGCGGCGCGGCAGCGCACGAAGGCCCTCCCCGCCATTTCTTCTGCGGGCG
CCGACCCGCTTCGCCCGCGCCGCTAGAGGGGGTGGCGGCGGCGCTCCAGATTTCCGGCTCCGCCA
GATTTGGGACAAAGGAAGTCCCTGCGCCCTCTCGCACGATTACCATAAAAGGCAATGGCTGCGGCT
CGCCGCGCTCGACAGCCGCGGCGCTCCGGGGCCGCGCGCCCTCCCCGAGCCCTCCCCGGCC

cgaggcgccccgccccgccccgccccacccccacctgcccgcaccccccgccccgacggcgagcccc
gcgccacgccccgcacggagccccgcacccgaagccgggcccgtgctcagcaactcggggagggggg
tgcaggggggggttacagcccgaaccgcccgcacacccccctgctacccccccacgcacacacc
ccgcacgcagcctttgttcccctcgcagccccccccgcacccgccccgacccgccccggccgcgctc
ccctcgcgcacacgcggagcgcacaaagccccgcccgcgcccgcagcgcctcacagccgccccgca
gcgccccgacgcggcgctccccacgcacacacacacgcacgcaccccccgagccgctcccccc
cgcacaaagggccctcccggagccctttaaggctttcacgcagccacagaaaagaaacgagccgctc
attaaccaagcgctaattacagcccggaggagaagggccgtcccgcgctcacctgtgggagta
acgcggtcagtcagagccccggggcgggcgaggcgccgagcggggcacggggcgaaggca
acgcagcgaactcccgcgcccgcgcttcgctttttatagggccgcccgcgcccgcctcgcca
taaaggaaactttcggagcgcgcccgtctgattggctgcccgcacacctctccgcctgccccgc
cccgcccctcgccccgccccgccccgcctggcgcgccccccccccccccccccccccatcgctgca
caaaataattaaaaataaataaatacaaaattgggggtggggaggggggggagatggggagagtg
aagcagaacgtggggctcacctcgacccatgagtaatagcgatgactaatacgtagatgtactgcc
aagtaggaaagtcccataaggtcatgtactggcataatgccaggcggggccatttacgctattga
cgtcaatagggggcgtacttggcatatgatacacttgatgtactgccaaagtgggcagtttacgta
aatagtccaccattgacgtcaatggaaagtcctattggcgttactatgggaacatacgtcatta
ttgacgtcaatggcgggggcgttggcggtcagccaggcggggccatttacgtaagttatgtaa
cgcggaactccatataatgggctatgaactaatgaccccgtaattgattactattaataacgtatac
tagtatcgtagatcgatccatctaattggaaccagataagtgaaatctagttccaaactattttg
tcatttttaattttcgtattagcttacgcgctacacccagttcccacatctattttgtcactcttc
ctaaataatccttaaaaactccattttccaccctcccagttcccaactattttgctccgcccaca -
3'

E.2.2 Donor vectors

E.2.2.1 pMDC: 2889 bp

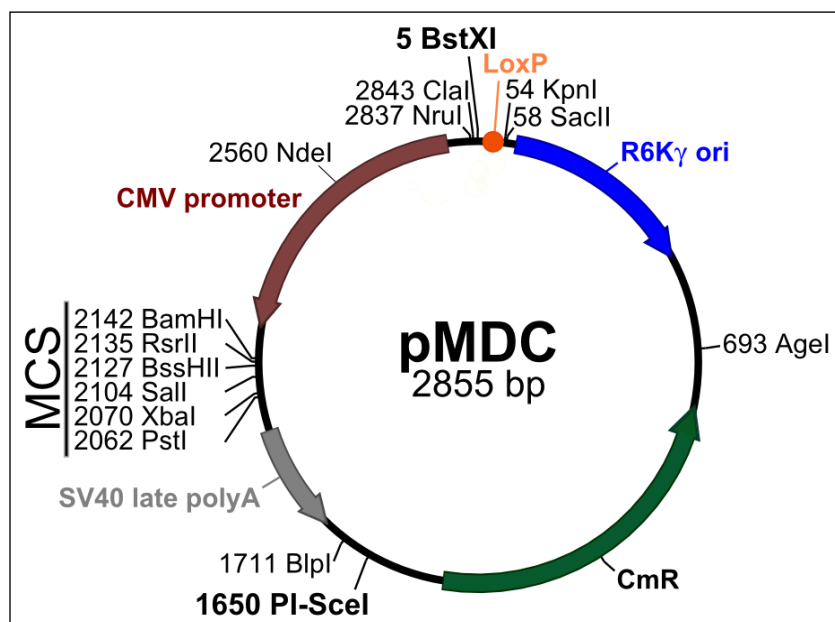

Multiple Cloning Site (promoter to terminator)

AGACCCAAAGCTGGCTAGT GGATCCCGGTCCGAAGCGCGCGGAATTCAAAGGCCTACGTCGAC
 SacI XbaI PstI
GAGCTCACTAGTCGCGGCCGCTTTTCGAATCTAGAGCCTGCAGTCTCGACAA

Enzymes that cut pMDC once (not exhaustive)

1302	AccIII, BspEI	54	Acc65I	693	Age I	1723	AvrII
2176	BamHI	1682	BglII	2161	BssHII	5	BstXI
643	Bsu36I	2877	ClaI	1957	HpaI	54	KpnI
1968	MfeI	2849	MluI	1033	MscI	2871	NruI
2096	PstI	2169	RsrII	58	SacII	2138	Sall
988	SspI	2146	StuI	2104	XbaI		

Bold type: restriction enzymes cutting in the MCS

Enzymes that cut pMDC twice (not exhaustive)

768, 2110	BstBI	61, 2118	BstZI, EagI	1298, 2154	EcoRI
349, 2083	HindIII	997, 2467	NcoI	60, 2117	NotI
1634, 1668	PfIMI	316, 1937	PsiI	573, 1400	PvuII
2132, 2263	SacI	883, 2070	Scal	107, 2489	SnaBI

Enzymes that do not cut pMDC (not exhaustive)

AfeI	AflII	AlwNI	ApaI	AscI	BbeI
BbsI	BclI	BspHI	BstZ17I	Drall	EcoNI
EcoRV	FseI	FspI	KasI	NaeI	NarI

NheI	NsiI	PacI	PmeI	PvuI	SbfI
ScI	SfiI	SgfI	SmaI	SphI	XcmI
XhoI	XmaI	XmnI			

Sequence

5' -

aaacccatgtgcctggcagataaacttcgtataatgtatgctatacgaagttatggtagccggcgccgctagaggat
ctgttgatcagcagttcaacctgttgatagtagcgtactaagctctcatgtttcacgtactaagctctcatgtttaa
cgtactaagctctcatgtttaacgaactaaacctcatggctaacgtactaagctctcatggctaacgtactaagc
tctcatgtttcacgtactaagctctcatgtttgaacaataaaattaatataaatcagcaacttaaatagcctctaa
ggttttaagttttataagaaaaaaaaagaatatataaggcttttaagcttttaaggtttaacgggttgaggacaaca
agccagggatgtaacgcactgagaagcccttagagcctctcaaagcaattttgagtgacacaggaacacttaacgg
ctgacatgggaattagcttcacgctgccgcaagcactcagggcgcaagggctgctaaaggaagcggaaacagtaga
aagccagtcgagcaaacgggtgctgaccccgatgaatgtcagctgggagggcagaataaatgatcatatcgtcaat
tattacctccacggggagagcctgagcaaacctggcctcagggcatttgagaagcacacgggtcacactgcttcggta
gtcaataaacgggtaaacagcaatagacataagcggctatTTAACGACCCTGCCCTGAACCGACGACCGGGTCGA
ATTTGCTTTCGAATTTCTGCCATTCACCGCTTATTATCACTTATTCAGGCGTAGCAACCAGGCGTTAAGGGCAC
CAATAACTGCCTTAAAAAATTACGCCCGCCCTGCCACTCATCGCAGTACTGTTGTAATTCATTAAGCATTCTGC
CGACATGGAAGCCATCACAACGGCATGATGAACCTGAATCGCCAGCGGCATCAGCACCTTGTGCGCTTGCCTATA
ATATTTGCCCATGGTGAAAACGGGGCGAAGAAGTTGTCCATATTTGGCCAGTTTTAAATCAAACTGGTGAAACTC
ACCAGGGATTGGCTGAGACGAAAAACATATTTCTCAATAAACCTTTAGGGAAATAGGCCAGGTTTTCAACGGTAAC
ACGCCACATCTTGCGAATATATGTGTAGAAACTGCCGGAATCGTCGTGGTATTCACTCCAGAGCGATGAAAACGT
TTCAGTTTGTCTCATGGAAAACGGTGAACAAGGGTGAACACTATCCCATATCACCAGCTCACCGTCTTTCATTGCC
ATACGGAATTCGGATGAGCATTTCATCAGGCGGGCAAGAATGTGAATAAAGGCCGGATAAACTTGTGCTTATTTT
TCTTACGGTCTTTAAAAAGCCGTAATATCCAGCTGAACGGTCTGGTTATAGGTACATTGAGCAACTGCAATGAA
TGCTCAAAAATGTTCTTTACGATGCCATTGGGATATATCAACGGTGGTATATCCAGTGAATTTTTCTCCATTTTA
GCTTCCTTAGCTCCTGAAAATCTCGATAACTCAAAAAATACGCCCGGTAGTGTATCTTATTTTATTATGGTGAAAGT
TGGACCCTCTTACGTCCGATCAACGTCTCATTTTTCGCCAAAAGTTGGCCAGATCTATGTGCGGTGCGGAGAAAAG
AGGTAATGAAATGGCACCTAGGGTTATGATAGTTATTGCTCAGCGGTGGCAGCAGCCAACCTCAGCTTCTTTCGG
GCTTTGTTAGCAGCCGGATCTTCTAGGCTCAAGCAGTGTATCAGATCCAGACATGATAAGATACATTGATGAGTTG
GACAAACCACAACCTAGAATGCAGTGAAAAAATGCTTTATTTGTGAAATTTGTGATGCTATTGCTTTATTTGTAAC
CATTATAAGCTGCAATAACAAGTTAACAACAACAATTGCATTCATTTTTATGTTTCAGGTTCCAGGGGGAGGTGTGG
GAGGTTTTTTAAAGCAAGTAAACCTCTACAAATGTGGTATGGCTGATTATGATCCTCTAGTACTTCTCGACAAGC
TTGTCGAGACTGCAGGCTCTAGATTCGAAAGCGGCCGCGACTAGTGAAGTCTGTCGACGTAGGCCTTTGAATTCGCG
GCGCTTCGGACCGGATCCACTAGCCAGCTTGGGTCTCCCTATAGTGAAGTCTGATTAATTTGATAAGCCAGTAAG
CAGTGGGTTCTCTAGTTAGCCAGAGAGCTCTGCTTATATAGACCTCCACCCTACACGCCTACCGCCCATTTGCGT
CAATGGGGCGGAGTTGTTACGACATTTTGGAAAGTCCCGTTGATTTTTGGTGCCAAAACAAACTCCCATTTGACGTCA
ATGGGGTGGAGACTTGGAAATCCCGTGAGTCAAACCGCTATCCACGCCCATTTGATGTACTGCCAAAACCGCATCA
CCATGGTAATAGCGATGACTAATACGTAGATGTACTGCCAAGTAGGAAAGTCCCATAGGTCATGTACTGGGCATA
ATGCCAGGCGGGCCATTTACCGTCATTGACGTCAATAGGGGGCGTACTTGGCATATGATACACTTGTGTACTGCC
AAGTGGGCAGTTTACCCTAAATACTCCACCATTGACGTCAATGGAAAGTCCCTATTGGCGTTACTATGGGAACAT
ACGTCAATATTGACGTCAATGGGCGGGGTGCTTGGGCGGTGAGCCAGGCGGGCCATTTACCCTAAGTTATGTAAC
GCGGAACCTCATATATGGGCTATGAACCAATGACCCCGTAATTGATTACTATTAATAACTAGTCAATAATCAATGT
CAACGCTATATCTGGCCCGTACATCGCGAATCGATACTAGTA

-3'

E.2.2.2 pMDK: 4130 bp

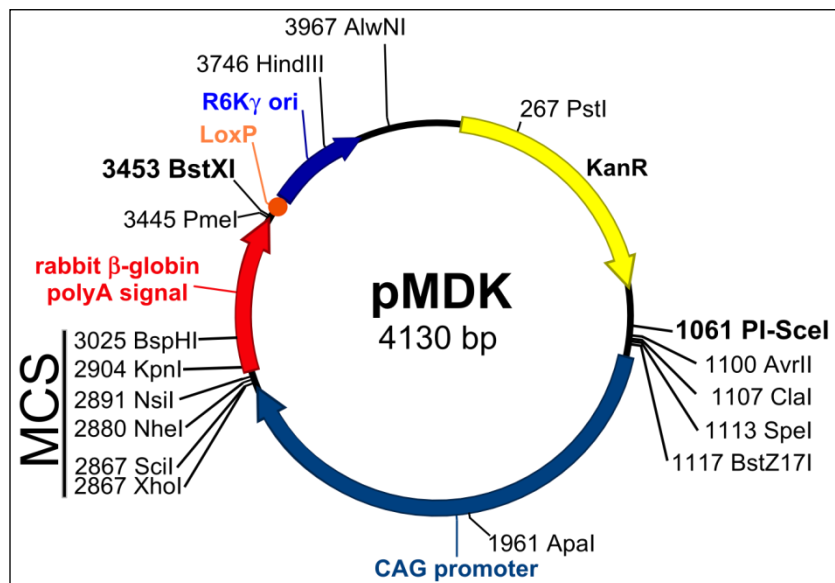

Multiple Cloning Site (promoter to terminator)

```

                                     BbsI                               SciI
                                     XhoI                               NcoI
                                     NheI
GCGGCCGTCTCAGGCCACC GAAGACTTGATCACCCGGGATCTCGAGCCATGGTGCTAGCAGCT
                                     Acc65I
NsiI                               KpnI
GATGCATAGCATGCGGTACCTAA
    
```

Enzymes that cut pMDK once (not exhaustive)

2904	Acc65I, KpnI	3967	AlwNI	1961	Apal	1100	AvrII
3025	BspHI	899	BstBI	3453	BstXI	1117	BstZ17I
2919	Bsu36I	1107	ClaI	318	FspI	3746	HindIII
298	MscI	2873	NcoI	2880	NheI	2891	NsiI
3190	PfIMI	3445	PmeI	267	PstI	733	RsrII
2129	SacII	1113	SpeI	27	XcmI	2867	XhoI

Bold type: restriction enzymes cutting in the MCS

Enzymes that cut pMDK twice (not exhaustive)

1894, 2056	AfeI	1126, 3668	Asel	54, 2990	BglII
993, 1954	PfoI	1055, 2859	Smal, XmaI	1458, 3504	SnaBI
619, 2898	SphI				

Enzymes that do not cut pMDK (not exhaustive)

AccII	AclI	AflII	AgeI	ApalI	AscI
BamHI	BclI	BspEI	EcoNI	EcoRI	EcoRV
FseI	HpaI	MfeI	MluI	NotI	NruI
Pacl	PvuI	SacI	SalI	SbfI	Scal

Sfil Sgfl Sspl Stul Xbal XmnI

Sequence

5' -

aagtaaactggatggcttttcttgccgccaaggatctgatggcgcaggggatcaagatctgatcaag
agacaggatgaggatcgtttcgcatgattgaacaagatggattgcacgcaggttctccggccgctt
gggtggagaggctattcggctatgactgggcacaacagacaatcggctgctctgatgccgccgtgt
tccggctgtcagcgcaggggcccgggttctttttgtcaagaccgacctgtccgggtgcctgaatg
aactgcaggacgaggcagcgcggctatcgtggctggccacgacgggcgtccttgcgcagctgtgc
tcgacgttgtcactgaagcgggaagggactggctgctattgggcgaagtgccggggcaggatctcc
tgtcatctcaccttgctcctgcccagaaaagtatccatcatggctgatgcaatgcggcggctgata
cgcttgatccggctacctgcccattcgaccaccaagcgaacatcgcatcgagcgcagcagctactc
ggatggaagccggtccttgtcgcacagatgatctggacgaagagcatcaggggctcgcgccagccg
aactgttcgccaggctcaaggcgcgcacgcccgcggcaggatctcgtcgtgacacatggcgcag
cctgcttgcccgaatatcatgggtgaaaatggccgcttttctggattcatcgactgtggccggctgg
gtgtggcggaccgctatcaggacatagcgttggctacccgtgatattgctgaagagcttggcggcg
aatgggctgaccgcttctcgtgctttacggatcgcgcctcccgattcgcagcgcacgcttct
atcgcttcttgacgagttcttctgagcgggactctggggttcgaaatgaccgaccaagcgcgc
caacctgccatcacgagatttcgattccaccgccccttctatgaaagggtgggcttcggaatcgt
tttccgggacgcccggctggatgatcctccagcgcggggatctcatgctggagttcttcgccaccc
cgggatctatgtcgggtgcgggagaaagaggaatgaaatggcacctaggtatcgatactagtatac
gttattaatagtaataattacggggctattagttcatagcccatatatggagttccgcgcttacat
aactacggtaaatggcccgcctggctgaccgccaacgacccccgccattgacgtcaataatga
cgtatgttcccatagtaacgccaatagggactttccattgacgtcaatgggtggactatttacggt
aaactgccacttggcagtacatcaagtgtatcatatgccaagtacgccccctattgacgtcaatg
acggtaaatggcccgcctggcattatgccagtacatgaccttatgggactttcctacttggcagt
acatctacgtattagtcacgctattactcatgggtcgaggtgagccccacgttctgcttactct
ccccatctccccccctccccaccccccaattttgtatttattttttaattattttgtgcagc
gatgggggcccggggggggggggggcgcgccagggcggggcggggcggggcgaggggcccggg
cgaggcggagaggtgcccgcagccaatcagagcggcgcgctccgaaagtctcttttatggcga
ggcggcggcggcggcggccctataaaaagcgaagcgcgcggcggggcgggagtcgctgcttgcct
cgccccgtgccccgctcgcgcgcctcgcgcgcgcgcgcgcgcgcgcgcgcgcgcgcgcgcgc
cacaggtgagcgggcccggccttctcctccgggctgtaattagcgttggtttaatgacggc
tcgtttctttctgtggctgctgaaagccttaaagggtcgggagggccctttgtgccccggggg
agcggctcggggggtgctgctgctgctgctgctgctgctgctgctgctgctgctgctgctgctg
gcccgggggcccggcgcgggggggctgagggggaacaaaggctgctgctgctgctgctgctgctg
tgcgtgggggggtgagcagggggtgctgggcgcggcggctcgggctgtaacccccctgcaccccc
tccccgagttgctgagcacggcccggcttcgggtgcccgggctcctgctgcccgggctgctgctg
cgccgtgcccggcgggggggtggcggcaggtgggggtgcccgggcccgggcccggcctcgggccc
ggagggctcgggggaggggcccggcggcccccggagcgcggcggctgctgagggcgcggcagccg
agccattgccttttatggtaatcgtgagagagggcgcagggacttcttcttccaaatctggcgg
agccgaaatctgggagggcgcggcgcaccccccttagcgggcccgggccaagcgggtgcccgcgg
caggaaggaaatggggggggagggccttcgtgctgcccgcgcgcgcgcgcgcgcgcgcgcgcgc
gcctcggggctgcccagggggacggctgccttcgggggggacggggcagggcgggggttcggcttc
tggcgtgtgaccggcggctgctagagcctctgctaaccatgttcatgccttcttcttttcttaca
gctcctgggcaacgtgctggttgttgtgctgctcatcattttggcaagaattgcccggcgtctca
ggccaccgaagacttgatcaccgggatctcgagccatggtgctagcagctgatgcatagcatg
gtacctaatcactcctcaggtgcaggctgcctatcagaaggtggtggctggtgtggcctaagccc
tggctcacaataaccactgagatcttttccctctgcaaaaattatggggacatcatgaagcccc
ttgagcatctgacttctggctaataaaggaaatatttttatttgcaatagtgtgttggattttt
tgtgtctctcactcggaaagacatatgggagggcaaatcatttaaacatcagaatgagatattgg
tttagagtttggcaacatatgccatgctggctgccatgaacaaagggtggctataaagaggtcat

cagtatatgaaacagccccctgctgtccattccttattccatagaaaagccttgacttgaggtag
atTTTTTTTataTTTTgTTTTgTtTTTTTTTctTTaacatccctaaaTTTTccttacatggt
ttactagccagatTTTTcctcctctcctgactactcccagtcataagctgtccctcttctcttatga
agatccctcgacgTTTTaaacccatgtgcctggcagataacttcgtataatgtatgctatacgaagt
tatggtacgtactaagctctcatgTTTTcacgtactaagctctcatgTTTTaacgtactaagctctca
tgTTTaaCGaactaaaccctcatggctaacgtactaagctctcatggctaacgtactaagctctca
tgTTTcacgtactaagctctcatgTTTTgaacaataaaattaataaaatcagcaactaaatagcc
tctaaggTTTTaagTTTTataagaaaaaaaaagaatatataaggTTTTaaagTTTTaaggTTTTaa
cggTtTgTggacaacaagccaggatgtaacgcactgagaagcccttagagcctctcaaagcaattt
tcagtGacacaggaacacttaacggctGacagaattagcttcacgctgCCgcaagcactcagggcg
caagggtgctaaaggaagcGgaacacgtagaaagccagtcCGcagaaacggtgctgacCCcgat
gaatgtcagctactgggtatctggacaagggaaaacgcaagcGcaaagagaaagcaggtagcttg
cagTgggcttacatggcgatagctagactggcggtTTtatggacagcaagcgaaccggaattgcc
agctggggcgccctctggtaaggTtgggaagccctgca-3'

E.2.2.3 pMDS: 4088 bp

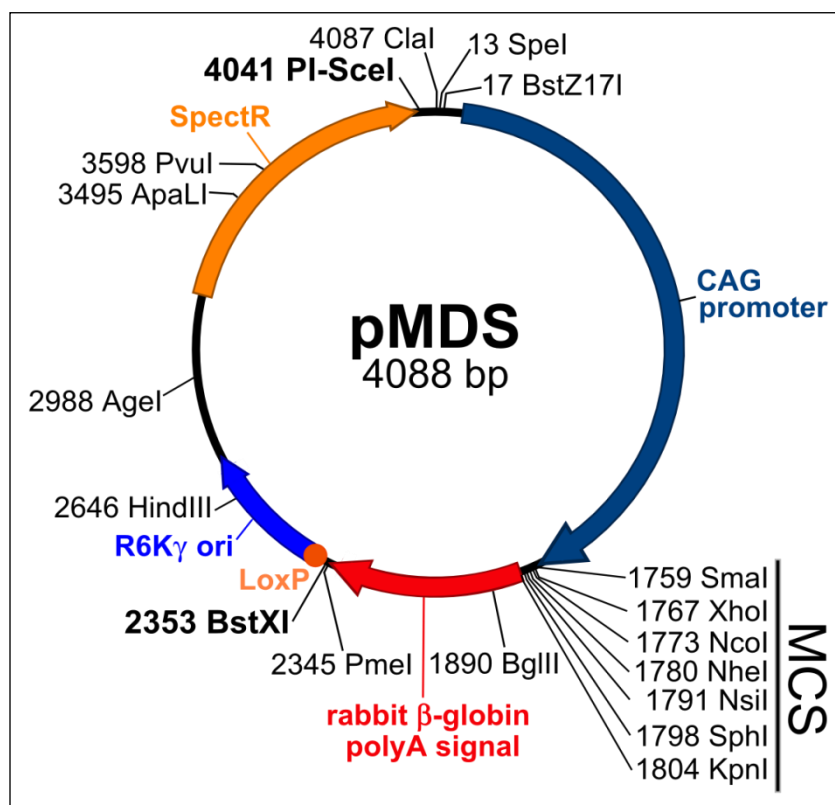

Multiple Cloning Site (promoter to terminator)

```

                                     BbsI           XmaI       SciI
                                     SmaI           XhoI       NcoI       NheI
GCGGCCGTCTCAGGCCACC GAAGACTTGATCACCCGGGATCTCGAGCCATGGTGCTAGCAGCT
                                     Acc65I
NsiI   SphI   KpnI
GATGCATAGCATGCGGTACCTAA
    
```

Enzymes that cut pMDS once (not exhaustive)

1804	Acc65I, KpnI	2988	AgeI	861	Apal	3495	ApaLI
4080	AvrII	1746	BbsI	1890	BglII	3380	BspEII
2353	BstXI	17	BstZ17I	4087	ClaI	2646	HindIII
1773	NcoI	1780	NheI	1791	NsiI	2090	PfIMI
2345	PmeI	2613	Psil	3598	PvuI	1029	SacII
1767	Scil	1759	SmaI, XmaI	13	SpeI	1798	SphI
1312	Sse232I	1767	XhoI				

Bold type: restriction enzymes cutting in the MCS

Enzymes that cut pMDS twice (not exhaustive)

794, 956	AfeI, VspI	26, 2568	AseI	1424, 1467	BbeI, NarI
1925, 3220	BspHI	1819, 2938	Bsu36I	1012, 1728	EagI
1785, 2868	PvuII	358, 2404	SnaBI		

Enzymes that do not cut pMDS (not exhaustive)

AclI	AlwNI	AscI	BamHI	BclI	BsaBI
BspEI	BstBI	EcoNI	EcoRI	EcoRV	FseI
FspI	HpaI	MfeI	MluI	MscI	NotI
NruI	PacI	PmlI	PstI	RsrII	SacI
SalI	SbfI	Scal	SfiI	SgfI	StuI
XbaI	XcmI	XmnI			

Sequence

5' -

cgatactacgatactagttatacgttattaatagtaatacaattacgggggtcattagttcatagccca
tatatggagttccgcgttacataacttacggtaaatggcccgcctggctgaccgcccacgacccc
cgcccattgacgtcaataatgacgtatgttcccatagtaacgccaatagggactttccattgacgt
caatgggtggactatttacggtaaacctgcccacttggcagtacatcaagtgtatcataatgccaagt
acgccccctattgacgtcaatgacggtaaatggcccgcctggcattatgcccagtacatgacctta
tgggactttcctacttggcagtacatctacgtatttagtcatcgctattactcatgggtcgaggtga
gccccacgttctgcttcaactctccccatctccccccccctccccaccccccaattttgtaattatta
tttttaattattttggtgcagcgatgggggccccggggggggggggggcgcgccaggcgggggcg
cgggcgagggggcgggggcggggaggggaggggaggggaggggaggggaggggaggggaggggag
cgaaagtttccctttatggcgagggcgggcgggcgggcgggccctataaaaagcgaagcgcgggcg
gcgggagtgctgcttgccttgccttgccttgccttgccttgccttgccttgccttgccttgccttgc
ctctgactgaccggttactcccacaggtgagcgggcgggacggcccttctcctccgggctgtaaat
tagcgcttgggttaataagcggctcgtttctttctgtggctgctgaaagccttaaagggtcctcg
gagggccctttgtgcggggggagcggtcgggggggtgctgctgctgctgctgctgctgctgctgct
cgct
cgct
caaaggct
gtaacccccctgacccccctccccgagttgctgagcacggccccgcttccgggtgctgctgctgctgct
gtgct
gggccccctcgggccccgggagggctcgggggaggggaggggaggggaggggaggggaggggagggg
ctgctgagggcgggcgagccgagccattgccttttatggtaatcgtgctgagagggcgaggggact
tcctttgtcccaaatctggcgagccgaaatctgggagggcgcccgccacccccctctagcgggagc
gggcaagcgggtgctgctgctgctgctgctgctgctgctgctgctgctgctgctgctgctgctgctgct
gcccctccttctccatctccagcctcggggctgctgctgctgctgctgctgctgctgctgctgctgctgct
gggaggggaggggttcggcttctggcgtgctgacggcgggctgctgctgctgctgctgctgctgctgctgct
atgcttct
gcaaagaattgcggcctctcaggccaccgaagacttgatcacccgggatctcgagccatgggtgct
agcagctgatgcatagcatgcggtacctaattcactcctcaggtgcaggctgcctatcagaagggtg
gtggctggtggtgctaatgcccggctcacaataaccactgagatcttttccctctgcccccaaat
tatgggacatcatgaagccccctgagcatctgacttctggctaataaaggaaatatttttattttcatt
gcaatagtgtggtggaatttttgtgtctctcactcgggaaggacatatgggagggcaaatcattta
aacatcagaatgagatatttggttagagttggcaacatatgccatatgctggctgccatgaaca
aagggtggctataaagaggtcatcagtatatgaaacagccccctgctgtcatttcttattccatag
aaaagccttgacttgagggttagattttttttatatttttgtttttgttttttttttctttaaactc
cctaaaattttcttcatgttttactagccagatttttcctcctctcctgactactcccagtcatt
agctgtccctcttctcttattgaagatccctcgactttaaaccctatgtgctggcagataacttcg
tataatgtatgctatacgaagtattggtactgactaagctctcatgtttcacgtactaagctctca
tgtttaacgtactaagctctcatgtttaacgaactaaaccctcatggctaacgtactaagctctca
tggctaacgtactaagctctcatgtttcacgtactaagctctcatgtttgaaacaataaaattaata
taaatcagcaacttaaatagcctctaagggttttaagttttataagaaaaaaagaatataaaggc
ttttaagcttttaagggttaacgggttggtgacaacaagccagggatgtaacgcactgagaagccc

ttagagcctctcaaagcaatTTTtgagtGACacaggaacacttaacggctGACataattcagcttca
cgctGCCgcaagcactcagggCGcaagggctGctaaaggaagCGgaacacgtagaaagccagtcCG
cagaaacggTgctgacCCcgatgaatgtcagctgggagGCagaataaatgatcatatcgtcaatt
attacctccacggggagagcctgagcaaacTggcctcaggcatttgagaagcacacggTcacactg
cttccggtagtcaataaacCGtaagtagcgtatgcgctcagcaactggTccagaaccttgaccg
aacgcagcggTggtaacggCGcagTggcggttttcatggcttgTtatgactgtttttttggggTAC
agtctatgcctcgggcatccaagcagcaagcgcgTtacgccgtgggTcgatgtttgatgttatgga
gcagcaacgatgttacgcagcagggcagTcgccctaaaacaaagTtaaacatcatgagggaaagcgg
tgatCGccgaagtatcgactcaactatcagaggtagTtgCGctcatcgagCGccatctcgaaccga
cgttgctggccgtacatTTtgtagcggctccgagTggatggCGcctgaagccacacagTgatattg
atttgctggTtacggTgaccgtaaggcttgatgaaacaacCGggcgagctttgatcaacgaccttt
tgaaacttcggcttcccctggagagagcGagattctccgCGctgtagaagTcaccattgttTgtc
acgacgacatcattccgTggcgTtatccagctaagcCGgaactgcaatttgagaatggcagcGca
atgacattcttgaggtatcttcgagccagccagatcgacattgatctggctatcttgctgacaa
aagcaagagaacatagcgtTgcctTgtaggtccagCGgCGgaggaactctttgatccggTtctg
aacaggatctatTTgagggCGctaaatgaaaccttaacgctatggaaactCGccgcccgactgggctg
gcgatgagCGaaatgtagTgcttacgtTgtcccGcattTggtacagCGcagtaaccggcaaaatCG
CGccgaaggatgtCGctGCCgactgggcaatggagCGcctGCCggccagTatcagccCGtcatac
ttgaagctagacaggcttatctTggacaagaagaagatCGctTggcctCGCGCGcagatcagTtg
aagaatTTgtccactacgtgaaaggCGagatcaccaaggtagTcgGcaaaataatgtctaacaattc
gttcaagccgacggatctatgtCGggTgCGgagaaagaggtaatgaaatggcacctaggtat -3'

E.3 DH10EMBacVSV™ Baculoviral Genome

The genome (size approx. 130 kb) is a derivative of the *Autographa californica* nucleopolyhedrovirus (AcMNPV) genome. It has been genetically engineered for improved protein production and reduced protein degradation. In addition, it contains an element for accepting donor DNA into its transposition acceptor site (mini-attTn7) that concomitantly allows blue-white selection to identify successful transposition events. The bacmid possesses the F replicon from the F plasmid that keeps the plasmid copy number at 1 (single copy).

It is hosted in DH10EMBacVSV™ *E.coli* cells and can be isolated from the bacteria using commercial “large construct” kits (e.g. Qiagen) or appropriate protocols for preparation of large DNA molecules (e.g. King et al., 2007).

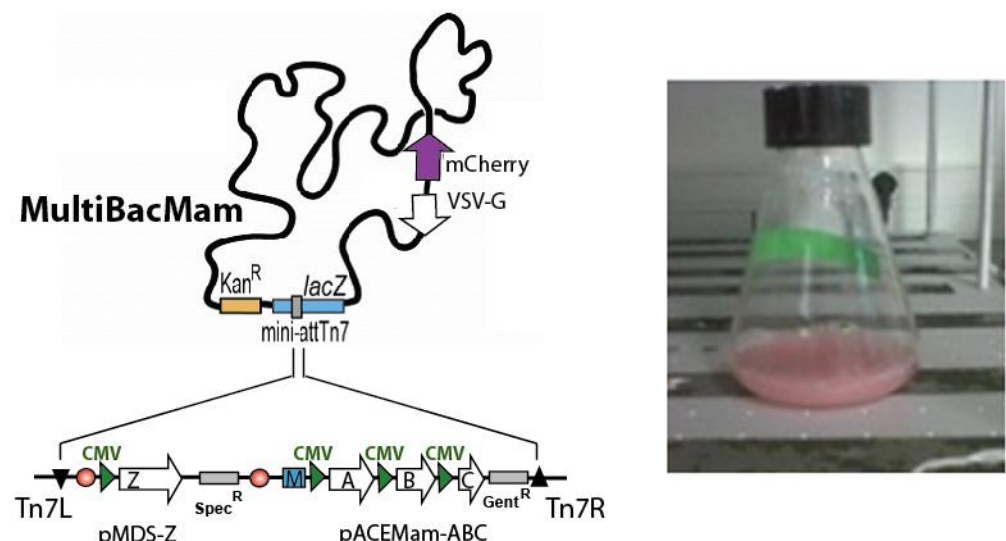

The image contains a schematic diagram of the MultiBacMam genome on the left and a photograph of a shaker culture flask on the right. The schematic diagram shows a circular genome with several key features: a Kan^R resistance cassette, a lacZ gene, a mini-attTn7 site, and an mCherry expression cassette. Below the main genome, two plasmids are shown: pMDS-Z, which contains a CMV promoter, a Z gene, a Spec^R resistance cassette, and a Tn7L site; and pACEMam-ABC, which contains a CMV promoter, an M gene, and three CMV promoters driving A, B, and C genes, along with a Gent^R resistance cassette and a Tn7R site. The photograph shows a flask with a pinkish-red liquid, indicating mCherry expression.

The MultiBacMam™ genome is called DH10EMBacVSV™ (left is a schematic diagram), and shaker culture (right) of virus in insect cells infected with this genome, produce a deep wine red color due to the presence of an mCherry expression cassette in the virus backbone.

E.4 Compatibility of Mammalian Cells for BacMam-Mediated Transduction

Cell Types Transduced using BacMam Technology Reference / Lab Transduction Efficiency

Primates

Human cells

143B (osteosarcoma, ATCC CRL-8303)	39	>90%
143TK- (fibroblast)	10	N/A
A549 (ATCC CCL-185, lung carcinoma)	41	N/A
BGC-823 (gastric carcinoma)	39	80%
Bone marrow fibroblasts	5	N/A
C3A liver cells	29	N/A
Cal-51 (human mammary carcinoma)	M. Mueller, U. Heidelberg	50% - 60%
CHP212 (neuroblastoma)	9	N/A
Colo-205 epithelial cells	C. Henery, Amnis Corp.	70% - 80%
CRL-1973 (NTERA-2, Nt-2; malignant pluripotent embryonal carcinoma)	4, Molecular Probes	N/A
DLS-1	13	N/A
DMS 114 (ATCC CRL-2066, small cell lung carcinoma)	39	80%
EA.hy926 (hybridoma of HUVEC and A549)	41	10% - 70%
Embryonic lung fibroblasts	11	N/A
FLC4 (human hepatocarcinoma)	15	N/A
Glioma: BT4C, BT325, BTL2 C6, H4, H52, H80, SW1088, SW1783, U87, U87MG, U251, U373, U373MG	Genetech, 28, 35, 46, 50	80% - 90%
HEK 293	2,5,15,27,39	>90%
HeLa	4,5,9,15,18,19,39	60% - >90%
HepG2 (ATCC HB-8065, hepatocellular carcinoma)	1,2,15,34, 39, 47	>90%
HuH-7 (hepatoma)	1,4,5,15,19, 53	>90%
Human adipose mesenchymal stem cells (MSC)	Invitrogen	>90%
Human bone-marrow derived mesenchymal stem cells (MSC)	Invitrogen	80%
Human dendritic cells	25	15%
Human embryonic stem cells (HES)	Invitrogen, 30	25% - 80%
Human embryonic neural stem cells	9	30%
Human mesenchymal stem cells (MSC)(from umbilical chord blood and bone marrow)	20, 49	70%
IMR-32 neuroblastoma (ATCC CCL-127) following differentiation	4,32	N/A
K-562 (ATCC CCL-243, chronic myelogenous leukemia)	5	15%
KATO-III (HTB-103, gastric carcinoma)	4	N/A
Keratinocytes	5	N/A
LNCaP (human prostatic adenocarcinoma)	F.Matthieu, U. Science et technologies de Lille	N/A

MCF7 (ATCC HTB-22D, breast cancer cell line)	NIH-NCI, 39	>80%
MG63 (ATCC CRL-1427, osteosarcoma)	5	>90%
MRC-5 (lung fibroblast)	7, 53	N/A
Pancreatic b-cells	8	N/A
PLC/PRF/5 (hepatoma; ATCC CRL-8024)	39	>90%
Prenatal cardiomyocytes (hCM)	18	N/A
Primary bone marrow fibroblasts	5	80%
Primary dendritic cells	25	N/A
Primary human aortic smooth muscle cells (HASMC)	Cascade Biologics	>80%
Primary human astrocytes	9	N/A
Primary human cardiomyocytes	18	90%
Primary human chondrocytes	NIH	N/A
Primary human coronary artery endothelia cells (HCEC)	18	40%
Primary human coronary smooth muscle cells (HCASMC)	18	80%
Primary human dermal fibroblasts - adult (HDFa)	Cascade Biologics	>90%
Primary human dermal fibroblasts - neonatal (HDFn)	Cascade Biologics	>90%
Primary human fibroblasts (HFB)	18, Cascade Biologics	>90%
Primary human foreskin fibroblasts (HFF)	5, 12, 28	30%
Primary human glial cells	9	~60%
Primary human hepatic stellate cells	19, 23	90%
Primary human hepatocytes	1, 2, 5, Molecular Probes	>90%
Primary human keratinocytes (HEK)	5, Cascade Biologics	>90%
Primary human lung fibroblasts	NIH	N/A
Primary human mammary epithelial cells (HMEC)	Cascade Biologics	>90%
Primary human melanocytes	Cascade Biologics	>90%
Primary human neuroepithelial and neuroblastic cells	9	N/A
Primary human pancreatic islet cells	8	N/A
Primary umbilical vein endothelial cells (HUVEC)	28, Molecular Probes	90%
Saos-2	5,6,19, 38	>90%
SHSY-5Y (neuroblastoma)	27,29	N/A
SK-BR-3	Molecular Probes	N/A
SK-N-MC	5	>90%
SK-OV-3 (ATCC HTB-77, adenocarcinoma)	50	N/A
T47D (breast carcinoma)	36	N/A
U-2 OS	27, Molecular Probes	>90%
W12 (human cervical keratinocyte)	5	>90%
WI38 (human lung fibroblast)	5, 39	>90%

Non-human primate cells

COS-7 (African green monkey kidney fibroblast-like cells)	3,4,5,9, Molecular Probes	>90%
CV-1 (normal African green monkey kidney)	5,15, 39, Molecular Probes	>90%

fibroblast cells)		
Vero	14, A.Snyder, OHSU	50%
Ruminants		
Bovine cells		
MDB (bovine kidney) epithelial cell line	5	N/A
BT (bovine turbinate) epithelial cell line (ATCC CRL-1390)	5	N/A
Ovine (Sheep) cells		
FLL-YFT (fetal lamb lung) cell line	5	N/A
Cervidae (Deer) cells		
Indian Muntjac deer epidermis cell line	M. Davidson, Molecular Expressions Inc.	N/A
Suidae (Pig)		
Suis (Pig) cells		
CPK (porcine kidney)	4,5	N/A
FS-L3 (porcine kidney) epithelial cell line	4,5	N/A
PK-15 (porcine kidney; ATCC CCL-33)	5,34	N/A
Left atrial appendage progenitor cells - adult stem cells	M. Rutten and K. Gregory, OMLC	N/A
Porcine coronary artery smooth muscle cells (pCSMC)	18	
LLC-PK1 (kidney proximal tubule) cell line	27, M. Davidson, Molecular Expressions Inc.	N/A
Primary Cardiac Smooth Muscle Cells	M. Rutten and K. Gregory, OMLC	N/A
Carnivores		
FoLu (Gray fox lung fibroblasts)	M. Davidson, Molecular Expressions Inc.	N/A
MDCK (NBL-2; dog kidney)	Molecular Probes	N/A
Marsupials		
OK (opossum kidney) epithelial cell line	M. Davidson, Molecular Expressions Inc.	N/A
Rodents		
Hamster cells		
CHO (Chinese hamster ovary cells: CHO K1, CHO M1WT3, CHO-hIR)	5,15,31, Molecular Probes	75% - >90%
Mouse cells		
3T3 mouse fibroblasts	23, 38, 39, Molecular Probes	15% - 40%
BNL 1ME A7.7R.1 (ATCC TIB-75, mouse liver carcinoma)	39	75%
C2C12 (myoblast)	51	60%
Dendritic cells	36	15%
GnRH neuronal cells	S. Singh, Johns Hopkins	60% - 70%
JC (adenocarcinoma)	39	20%
L929 (ATCC CCL-1, subcutaneous connective tissue)	39	35%

Neuroblastoma (N2a)	9	N/A
P388D1 (ATCC CCL-46, lymphoma)	5	25%
Primary kidney cells	22	N/A
Primary pancreatic acinar cell	Customer	N/A
Primary pancreatic islet cells	8	85%
Primary ventricular cardiomyocytes	Collaborator	>90%
PT67 (embryo fibroblast)	39	10%
Sol 8 (myoblast)	51	75%
Potoroo (Rat Kangaroo) cells		
Ptk2	M. Davidson, Molecular Expressions Inc.	N/A
Rabbit cells		
CRL-2560 (RH/K30, MT-2; rabbit T-cell line)	4	N/A
Primary aortic smooth muscle cells (RaASMC)	41	40% - 75%
Primary chondrocytes	44	>75%
Primary chondrocytes (intervertebral disc nucleus pulposus cells, <i>in vitro</i> and <i>in vivo</i>)	24	85%
Primary hepatocytes	16	N/A
RK13 (normal rabbit kidney epithelial cells)	C. Harrison, U. Melbourne	>80%
Rat cells		
BHK	5,15,34	N/A
Brain choroid plexus cells (in vivo)	40	60% - >90%
Brain pericytes cell line	Molecular Probes	N/A
C17.2 cells (differentiated, multipotent neural stem cell line)	31	N/A
Neural stem cells	A. Moutri, Salk Institute	30%
PC12	4,5	20%
Primary cerebellar granule neurons	31	N/A
Primary chondrocytes	21, 42, 45	85%
Primary glial cells (astrocytes)	48	60% - 80%
Primary hepatic stellate cells	23	20% (fresh) and 90% (activated)
Primary hepatocytes	2	N/A
Primary myoblasts	51	75%
Primary rat tendon fibroblasts	K. Gardner, Michigan State Univ.	N/A
Primary spiral ganglion neurons	33	N/A
Rat2	M. Davidson, Molecular Expressions Inc.	
REF-52 (rat embryo fibroblast)	A. Cayemberg, Medical College of Wisconsin)	50%
RGM I	4	N/A
T6 (rat hepatic stellate cell line)	23	20%

References for BacMam-mediated Transduction of Mammalian Cells

1. Hofmann, C. et al. (1995) *Proc. Natl. Acad. Sci. USA* 92:10099-10103
2. Boyce, F.M. & Boucher, N. (1996) *Proc. Natl. Acad. Sci. USA* 93:2348-2352
3. Yap, C.-C. et al. (1997) *Virology* 231:192-200
4. Shoji, I. et al. (1997) *J. Gen. Virol.* 78:2657-2664
5. Condreay, J.P. et al. (1999) *Proc. Natl. Acad. Sci. USA* 96:127-132
6. Merrihew, R.V. et al. (2001) *J. Virol.* 75:903-909
7. Palambo, F. et al. (1998) *J. Virol.* 72:5025-5034
8. Ma, L. et al. (2000) *Diabetes* 49:1986-1991
9. Sarkis, C. et al. (2000) *Proc. Natl. Acad. Sci. USA* 98:14638-14643
10. Ye, G.J. et al. (2000) *J. Virol.* 74:1355-1363
11. Lopez, P. et al. (2001) *J. Virol.* 75:3832-3840
12. Dwarakanath, R.S. et al. (2001) *Virology* 284:297-307
13. Barsoum, J. et al. (1997) *Hum. Gene Ther.* 8:2011-2018
14. Airenne, K.J. et al. (2000) *Gene Ther.* 7:1499-1504
15. Tani, H. et al. (2001) *Virology* 279:343-353
16. Munger, J. & Roizman, B. (2001) *Proc. Natl. Acad. Sci. USA* 98:10410-10415
17. Ames, R.S. et al. (2004) *Receptors Channels* 10:117-124
18. Grassi, G. et al. (2006) *Arch. Virol.* 151:255-271
19. Nicholson, L.J. et al. (2005) *Mol. Ther.* 11:638-644
20. Ho, Y.-C. et al. (2005) *J. Gene Med.* 7:860-868
21. Ho, Y.-C. et al. (2004) *Biotechnol. Bioeng.* 88:643-651
22. Liang, C.Y. et al. (2004) *Arch. Virol.* 149:51-60
23. Gao, R. et al. (2002) *Liver* 22:15-22
24. Liu, X. et al. (2006) *Spine* 31:732-5
25. Strauss, R. et al. (2007) *Mol. Ther.* 15:193-202
26. Leisy, D.J. et al. (2003) *J. Gen. Virol.* 84:1173-8
27. Hassan, N.J. (2006) *Prot. Expr. Purif.* 47:591-8
28. Kronschnabl, M. & T. Stamminger (2003) *J. Gen. Virol.* 84:61-73
29. Andersson, M. et al. (2007) *BMC Cell Biol.* 8:6-16
30. Zeng, J. et al. (2007) *Stem Cells* 25:1055-1061
31. Li, Y. et al. (2004) *Exp. Physiol.* 90:39-44
32. Näsman, J. et al. (2006) *J. Neurosci.* 26:10658-10666
33. Wang, J. et al. (2006) *Neuro Report* 18:1329-1333
34. Gao, H. et al. (2007) *J. Biotechnol.* 131:138-143
35. Wang, C.Y. et al. (2006) *Cancer Res.* 66:5798-5806
36. Ping, W. et al. (2006) *Avian Dis.* 50:59-63
37. Long, G. et al. (2006) *J. Virol.* 80:8830-8833
38. Song, S.U. and Boyce, F.M (2001) *Exp. Mol. Med.* 33, 46–53
39. Cheng T et al. (2004) *World J. Gastroenterol.* 10:1612–18.
40. Laitinen, O.H. et al (2005) *NAR* 33:e42
41. Mähönen, A.J. et al. (2007) *J. Biotechnol.* 131:1-8
42. Lee, H.-P. et al. (2007) *J. Gene Med.* 9:33-43
43. Wagle, L. & S.Jesuthasan (2003) *Mar. Biotechnol.* 5:58-63
44. Shen, H.-C. et al. (2007) *J. Gene Med.* 9:470-478
45. Chan, Z.-R. et al. (2005) *Biotechnol. Bioeng.* 93:565-571
46. Lacker, A. et al. (2008) *Anal. Biochem.* 380:146-148
47. Matalainen, H. et al. (2005) *J. Virol.* 79:15452-15459
48. Wang, C.Y. and S. Wang (2006) *Gene Ther.* 13:1447-1456

49. Chuang, C.-K. et al. (2007) *Gene Ther.* 14:1417-1424
50. Kaikkonen, M.U. et al. (2006)
51. Shen, H.-C. et al. (2008) *J. Gene Med.* 10:1190-1197
52. Lehtolainen, P. et al. (2002) *Gene Ther.* 9:1693-1699
53. Palombo, F. et al. (1998) *J. Virol.* 72:5025-5034

F. References for whole manual

1. **Alberts B** (1998). The cell as a collection of protein machines: preparing the next generation of molecular biologists. *Cell* 92: 291-294.
2. **Ausubel F, Brent R, Kingston RE, Moore DD, Seidman JG, Smith JA, and Struhl K** (eds., 1994). *Current Protocols in Molecular Biology*. John Wiley & Sons, New York, electronic version DOI 10.1002/0471142727
3. **Bieniossek C, Nie Y, Frey D, Olieric N, Schaffitzel C, Collinson I, Romier C, Berger P, Richmond TJ, Steinmetz MO, Berger I** (2009). Automated unrestricted multigene recombineering for multiprotein complex production. *Nature Methods* 6: 447-450.
4. **Charbonnier S, Gallego O, and Gavin AC** (2008). The social network of a cell: Recent advances in interactome mapping. *Biotechnology Annual Review* 14: 1-28.
5. **Ehmsen J, Poon E, and Davies K** (2002). The dystrophin-associated protein complex. *Journal of Cell Science* 115: 2801-2803.
6. **Figeys D** (2008). Mapping the human protein interactome. *Cell Research* 18: 716-724.
7. **Imasaki T, Calero G, Cai G, Tsai K-L, Yamada K, Gardelli F, Erdjument-Bromage H, Tempst P, Berger I, Kornberg GL, Asturias FJ, Kornberg RL, and Takagi Y** (2011). Architecture of the Mediator head module. *Nature* 475: 240-245.
8. **Inoue H, Nojima H and Okayama H** (1990). High efficiency transformation of *Escherichia coli* with plasmids. *Gene* 96: 23-28.
9. **Robinson CV, Sali A, and Baumeister W** (2007). The molecular sociology of the cell. *Nature* 450: 973-982.
10. **Sambrook J and Russell DW** (2000). *Molecular Cloning, A Laboratory Manual*, 3rd edition. Cold Spring Harbor Laboratory Press, Cold Spring Harbor, available online at <http://cshprotocols.cshlp.org>
11. **Trowitzsch S et al.** (2010). New baculovirus expression tools for recombinant protein complex production. *Journal of Structural Biology* 172: 45-54, epub Feb 21, 2010, doi: 10.1016/j.jsb.2010.02.010
12. **Vidal M**, Cusick ME, and Barabási AL (2011). Interactome networks and human disease. *Cell* 144: 986-98.
13. **Vijayachandran LS, Viola C, et al.** (2011). Robots, pipelines, polyproteins: Enabling multiprotein expression in prokaryotic and eukaryotic cells. *Journal of Structural Biology* 175: 198-208.

We thank Dr. Imre Berger and his team from Bristol for their input and assistance in preparing this manual.

NOTES:

G. Purchaser Notification: Limited Use Label License

The purchase of this product conveys to the buyer the non-transferable right to use the purchased amount of the product and components of the product in research conducted by the buyer (whether the buyer is an academic or for-profit entity).

The buyer cannot sell or otherwise transfer **(a)** this product **(b)** its components or **(c)** materials made using this product or its components to a third party or otherwise use this product or its components or materials made using this product or its components for Commercial Purposes. The buyer may transfer information or materials made through the use of this product to a scientific collaborator, provided that such transfer is not for any Commercial Purpose, and that such collaborator agrees in writing **(a)** not to transfer such materials to any third party, and **(b)** to use such transferred materials and/or information solely for research and not for Commercial Purposes.

Commercial Purposes means any activity by a party for consideration and may include, but is not limited to: **(1)** use of the product or its components in manufacturing; **(2)** inclusion of the product as part of another product; **(3)** use of the product or its components to provide a service, information, or data; **(4)** use of the product or its components for *ex vivo* or *in vivo* therapeutic, diagnostic, prophylactic or other unauthorized commercial purposes; **(5)** use in foods, drugs, devices or cosmetics of any kind, or for consumption by or use in connection with or administration or application to humans or animals; **(6)** resale of the product or its components, whether or not such product or its components are resold for use in research, or **(7)** any use other than research use.

For products that are subject to multiple limited use label licenses, the terms of the most restrictive limited use label license shall control. Geneva Biotech will not assert a claim against the buyer of infringement of patents owned or controlled by Geneva Biotech which cover this product based upon the manufacture, use or sale of a therapeutic, clinical diagnostic, vaccine or prophylactic product developed in research by the buyer in which this product or its components was employed, provided that neither this product nor any of its components was used in the manufacture of such product.

If the purchaser does not agree with the terms or limitations of this limited use agreement, the customer can return the product at their own costs but for a full refund (excluding shipping, tax and handling fees).

For information about purchasing a license to use this product or the technology embedded in it for any use other than for research use please contact Geneva Biotech at contact@geneva-biotech.com